

Provided for non-commercial research and education use.
Not for reproduction, distribution or commercial use.

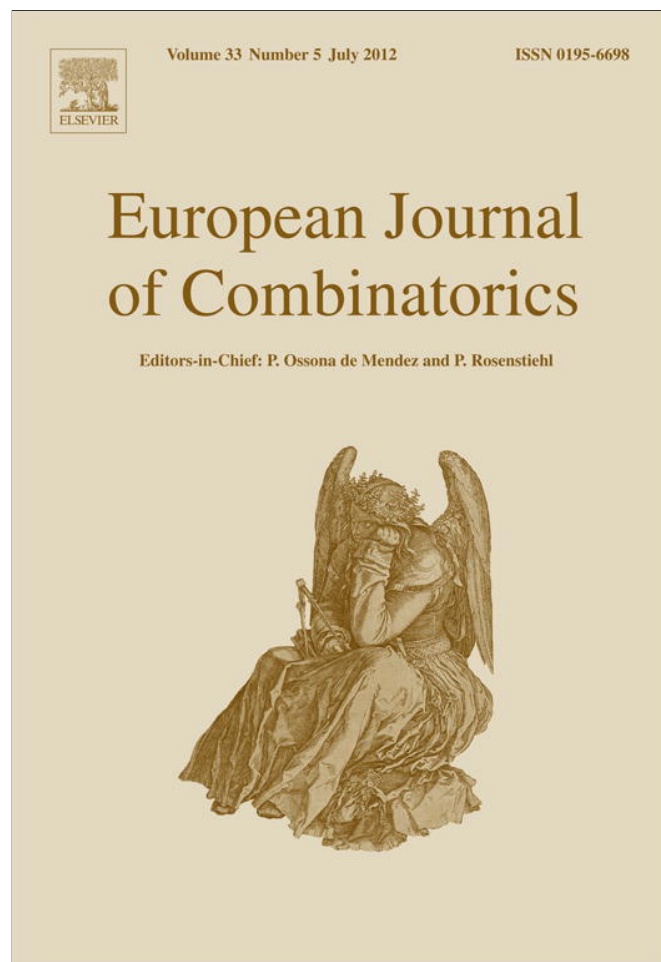

This article appeared in a journal published by Elsevier. The attached copy is furnished to the author for internal non-commercial research and education use, including for instruction at the authors institution and sharing with colleagues.

Other uses, including reproduction and distribution, or selling or licensing copies, or posting to personal, institutional or third party websites are prohibited.

In most cases authors are permitted to post their version of the article (e.g. in Word or Tex form) to their personal website or institutional repository. Authors requiring further information regarding Elsevier's archiving and manuscript policies are encouraged to visit:

<http://www.elsevier.com/copyright>



ELSEVIER

Contents lists available at SciVerse ScienceDirect

European Journal of Combinatorics

journal homepage: www.elsevier.com/locate/ejc

Outerplanar obstructions for a feedback vertex set[☆]

Juanjo Rué^a, Konstantinos S. Stavropoulos^b, Dimitrios M. Thilikos^b

^a Laboratoire d'Informatique, École Polytechnique, 91128 Palaiseau-Cedex, France

^b Department of Mathematics, National and Kapodistrian University of Athens, Athens, Greece

ARTICLE INFO

Article history:

Available online 17 October 2011

ABSTRACT

For $k \geq 1$, let \mathcal{F}_k be the class of graphs that contain k vertices meeting all its cycles. The *minor-obstruction set* for \mathcal{F}_k is the set $\mathbf{obs}(\mathcal{F}_k)$ containing all minor-minimal graphs that do not belong to \mathcal{F}_k . We denote by \mathcal{Y}_k the set of all outerplanar graphs in $\mathbf{obs}(\mathcal{F}_k)$. In this paper, we provide a precise characterization of the class \mathcal{Y}_k . Then, using singularity analysis over the counting series obtained with the Symbolic Method, we prove that $|\mathcal{Y}_k| \sim C' \cdot k^{-5/2} \cdot \rho^{-k}$ where $C' \doteq 0.02575057$ and $\rho^{-1} \doteq 14.49381704$ (ρ is the smallest positive root of a quadratic equation).

© 2011 Elsevier Ltd. All rights reserved.

1. Introduction

All graphs in this paper are simple. Given an edge $e = \{x, y\}$ of a graph G , the graph G/e is obtained from G by contracting e ; that is, to get G/e we identify the vertices x and y and remove all resulting loops and duplicate edges. A graph H obtained from a subgraph of G after a sequence of edge-contractions is said to be a *minor* of G . Given a graph class \mathcal{G} , we define its minor-obstruction set as the set of all minor-minimal graphs that do not belong to \mathcal{G} ; we denote it as $\mathbf{obs}(\mathcal{G})$. By the Robertson and Seymour Theorem [10], it follows that for every graph class \mathcal{G} , $\mathbf{obs}(\mathcal{G})$ is finite. An active field of research in Graph Minors Theory is to characterize or (upper/lower) bound the size of the obstruction set of certain graphs classes. The first result of this kind was the Kuratowski–Wagner Theorem concerning planar graphs.

Given a graph G , and a vertex set $S \subseteq V(G)$, we say that S is a *feedback vertex set* of G if $G \setminus S$ is acyclic. We denote by $\mathbf{fvs}(G)$ the minimum k for which G contains a feedback vertex set of size k . For any non-negative integer k , we denote as $\mathcal{F}_k = \{G \mid \mathbf{fvs}(G) \leq k\}$ (i.e. the class of graphs that contain a feedback vertex set of size at most k). We define $\mathbf{obs}(\mathcal{F}_k)$ as the set of all minor-minimal graphs not contained

[☆] A preliminary version of this paper was presented in Rué et al. (2009) [11].

E-mail addresses: juanjo.rue@icmat.es (J. Rué), kstavro@math.uoa.gr (K.S. Stavropoulos), sedthilk@math.uoa.gr (D.M. Thilikos).

in \mathcal{F}_k . Again by the Robertson and Seymour's Theorem, it is known that $\mathbf{obs}(\mathcal{F}_k)$ is finite for any k . Complete characterizations of $\mathbf{obs}(\mathcal{F}_k)$ have been provided for $k \leq 2$ in [4]. However, as remarked in [4], the number of obstructions for bigger values of k seems to grow quite rapidly. In this paper we provide a *precise* characterization of all outerplanar obstructions, for every $k \geq 1$, and we use the Symbolic Method developed by Flajolet and Sedgewick [6] to asymptotically count them. Such types of characterizations are known only for the acyclic obstructions of classes of bounded pathwidth [12] and its variations (search number [9], proper-pathwidth [12], linear-width [13]) and for the graphs of bounded tree-depth [7]. Moreover, this is the first time where an asymptotic enumeration of such a class has been derived.

Outline of the work: in Section 2, we set our notation and we recall the basic definitions concerning graph minors. The main structural result concerning the set of outerplanar obstructions for the feedback vertex set is stated in Section 3. Finally, in Section 4, we enumerate this family for a fixed level of obstruction, both exactly and asymptotically. In Section 5, we present some related conjectures.

2. Definitions

All graphs in this paper are simple (i.e. they have neither loops nor multiple edges). We denote by $V(G)$ (resp. $E(G)$) the vertex set (resp. edge set) of G . For any set $S \subseteq V(G)$, we denote as $G[S]$ the subgraph of G induced by the vertices in S . We also denote as $G \setminus S$ the graph $G[V(G) \setminus S]$. Given a vertex $v \in V(G)$, we use the notation $N_G(v)$ for the set of neighbors of v in G .

Feedback vertex set. Given a graph G , and a vertex set $S \subseteq V(G)$, we say that S is a *feedback vertex set* of G if $G \setminus S$ is acyclic (i.e. if each cycle of G is intersected by S). We denote by $\mathbf{fvs}(G)$ the minimum k for which G contains a feedback vertex set of size k . For any non-negative integer k , we denote as $\mathcal{F}_k = \{G \mid \mathbf{fvs}(G) \leq k\}$ (i.e. the class of graphs that contain a feedback vertex set of size at most k). We define $\mathbf{obs}(\mathcal{F}_k)$ as the set of all minor-minimal graphs not contained in \mathcal{F}_k . From [10], it is known that $\mathbf{obs}(\mathcal{F}_k)$ is finite for any k .

Gears. For any integer $r \geq 3$, we denote by C_r the cycle on r vertices. We also define A_r to be the graph, called a *gear with r teeth*, obtained by C_r if we add r vertices in C_r and then connect each of them with a (distinct) pair of adjacent vertices in C_r .

We use the term *triangle* for any clique on three vertices. Given a graph G , we call a vertex $u \in V(G)$ *2-simplicial* if u , together with its neighbors, induce a triangle in G . We call a triangle in G *simplicial* if one of its vertices is 2-simplicial. Let G_1, \dots, G_q be a sequence of graphs where $q \geq 2$. We define the class $\Delta(G_1, \dots, G_q)$ as the set containing any graph G that can be constructed as follows. Take a cycle C_{q+1} of length $q + 1$ with vertex set $\{v_0, \dots, v_q\}$ (we call it a *central cycle*) and for each $i \in \{1, \dots, q\}$, let $G'_i = G_i \setminus u_i$ where u_i is some 2-simplicial vertex of G_i , identify the set $N_{G_i}(u_i)$ of each G'_i with the vertices $\{v_{i-1}, v_i\}$ of C_{q+1} and remove multiple edges that appear. We call the edge $\{v_0, v_q\}$ the *lonely edge* of the central cycle of G . From now on we use u, v in order to codify 2-simplicial vertices and vertices belonging to central cycles, respectively.

Definition of the classes \mathcal{C}_k and \mathcal{Y}_k . We recursively define the graph classes $\mathcal{C}_k, \mathcal{Y}_k, k \geq 1$ as follows:

$$\mathcal{C}_k = \{A_{1+2k}\} \cup \left\{ G \mid G \in \Delta(G_1, \dots, G_q) \text{ for } G_i \in \mathcal{C}_{k_i}, i \in \{1, \dots, q\} \right.$$

$$\left. \text{where } \sum_{i=1}^q k_i = k \text{ and } \prod_{i=1}^q k_i > 0 \right\} \quad \text{and}$$

$$\mathcal{Y}_k = \left\{ G \mid G \text{ is the disjoint union of } G_1, \dots, G_l \text{ for } G_i \in \mathcal{C}_{k_i} \cup \{K_3\}, i \in \{1, \dots, l\} \right.$$

$$\left. \text{where } \sum_{i=1}^l (1 + k_i) = 1 + k \right\}.$$

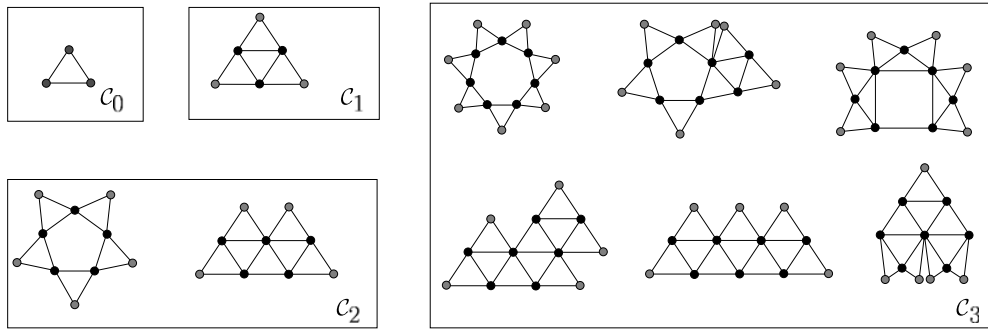

Fig. 1. The classes \mathcal{C}_0 , \mathcal{C}_1 , \mathcal{C}_2 , and \mathcal{C}_3 .

Given a graph G in either \mathcal{C}_k or \mathcal{Y}_k , we say that G has *level of obstruction* k . Consequently, the level of obstruction is the main parameter to take into account in order to study the enumeration of both $|\mathcal{C}_k|$ and $|\mathcal{Y}_k|$ (Fig. 1).

3. Outerplanar obstructions

Our first result is the following precise characterization of the (connected) outerplanar graphs in $\mathbf{obs}(\mathcal{F}_k)$, for every $k \geq 1$.

Theorem 1. Let \mathcal{B} (resp \mathcal{D}) be the class of all outerplanar (resp. connected outerplanar) graphs. Then, for every positive integer k , $\mathbf{obs}(\mathcal{F}_k) \cap \mathcal{D} = \mathcal{C}_k$ and $\mathbf{obs}(\mathcal{F}_k) \cap \mathcal{B} = \mathcal{Y}_k$.

The following lemma will be useful for proving both inclusion relations of the relation $\mathbf{obs}(\mathcal{F}_k) \cap \mathcal{D} = \mathcal{C}_k$ in Theorem 1.

Lemma 2. Let G_i , $i = 1, \dots, q$ be graphs where $\mathbf{fvs}(G_i) \geq k_i + 1$, $i = 1, \dots, q$. Let also $G \in \Delta(G_1, \dots, G_q)$. Then $\mathbf{fvs}(G) \geq k_1 + \dots + k_q + 1$.

Proof. Let $k = \sum_{i=1}^q k_i$ and let S be a feedback vertex set of G . Let $S_i = S \cap (V(G_i) \setminus v_{i-1} \setminus v_i) \geq k_i$, $i = 1, \dots, q$. We claim that, for $i = 1, \dots, q$, either $|S_i| \geq k_i$ or $|S_i| = k_i - 1$ and $v_{i-1}, v_i \in S$ (we use v_i 's as the definition of Δ in Section 2). Clearly $|S_i| \geq k_i - 1$, otherwise $S_i \cup \{v_{i-1}, v_i\}$ would be a feedback vertex set of G_i of size $< k_i + 1$. If $|S_i| = k_i - 1$, then at least one, say x , of v_{i-1}, v_i should belong to S (because $\mathbf{fvs}(G_i) \geq k_i$ implies that $|S \cap V(G_i)| \geq k_i$) and then $S_i \cup \{x\}$ would also be a feedback vertex set of G_i , a contradiction. If only one, say x , of v_{i-1}, v_i does not belong in S , then $|S \cap V(G_i)| = k_i$, $S \cap V(G_i)$ should also be a feedback vertex set of G_i and the claim holds. Let I now be the set of all indices in $\{1, \dots, q\}$ such that $|S_i| \geq k_i$ and let $J = \{1, \dots, q\} \setminus I$. Then $S \supseteq (\bigcup_{i=1}^q S_i) \cup (\bigcup_{i \in J} \{v_{i-1}, v_i\}) = (\bigcup_{i \in I} S_i) \cup (\bigcup_{i \in J} S_i) \cup (\bigcup_{i \in J} \{v_{i-1}, v_i\})$. Observe that the edges $\{v_{i-1}, v_i\}$, $i \in J$ induce an acyclic subgraph in C and such a graph has $\geq |J| + 1$ vertices. We conclude that $|S| \geq \sum_{i \in I} k_i + \sum_{i \in J} (k_i - 1) + |J| + 1 = k + 1$. \square

3.1. $\mathbf{obs}(\mathcal{F}_k) \cap \mathcal{D} \supseteq \mathcal{C}_k$

We call a pair of vertices x, y in a graph G *simplicial* if they are the neighbors of some vertex of degree two in G . We say that a graph is *typical* if every simplicial pair of vertices is contained in some feedback vertex set of G of size $\mathbf{fvs}(G)$.

Lemma 3. Let G_i , $i = 1, \dots, q$ be typical graphs where $G_i \in \mathbf{obs}(\mathcal{F}_{k_i})$, $i = 1, \dots, q$. Let also $G \in \Delta(G_1, \dots, G_q)$. Then G is typical and belongs in $\mathbf{obs}(\mathcal{F}_k)$ where $k = k_1 + \dots + k_q$.

Proof. As the lemma is obvious in case $q = 1$, we assume that $q \geq 2$. We set $G'_i = G_i \setminus u_i$, $i = 1, \dots, q$ and we denote by C the central cycle of G . Here v_0, \dots, v_q are the vertices of C and the u_i 's are as in the definition of Δ in Section 2. The lemma will follow by proving the next 4 claims.

Claim 1. A feedback vertex set of G'_i of size k_i contains neither vertex v_{i-1} nor v_i , for $i = 1, \dots, q$.

Proof. indeed, if this is not correct then the same feedback vertex set would also be a vertex feedback set of G_i of size k_i , a contradiction to the fact that $G_i \in \mathbf{obs}(\mathcal{F}_{k_i})$. \square

Claim 2. $\mathbf{fvs}(G) \leq k + 1$ and G is typical.

Proof. Let x, y be a simplicial pair in G . By the construction of G , x, y is also a simplicial pair in some G_i where $i \in \{1, \dots, q\}$. As G_i is typical, it contains a feedback vertex set S_i where $|S_i| = k_i + 1$ and such that $x, y \in S_i$. Furthermore, we can also assume that S_i is also a feedback vertex set of G'_i containing some of the vertices in $\{v_{i-1}, v_i\}$. Notice that for $j = 1, \dots, i - 1, i + 1, \dots, q$, G'_j has a feedback vertex set S_j of size k_j . If we now take the union S of the sets S_i , $i = 1, \dots, q$ as they appear in G , we have that all cycles corresponding to cycles of G'_i 's are intersected by S . Moreover S contains at least one vertex of C (namely v_{i-1} or v_i). We conclude that S is a feedback vertex set of G containing x and y and $|S| \leq |S_1| + \dots + |S_{i-1}| + |S_i| + |S_{i+1}| + \dots + |S_q| = k_1 + \dots + k_{i-1} + (k_i + 1) + k_{i+1} + \dots + k_q = k + 1$. The claim follows. \square

Claim 3. $\mathbf{fvs}(G) \geq k + 1$.

Proof. follows directly from Lemma 2. \square

Claim 4. For every edge e of G every graph J in $\{G \setminus e, G / e\}$ has a feedback vertex set of size $\leq k$.

Proof. We distinguish the following cases:

Case 1. $e = \{v_0, v_q\}$ and $J = G \setminus e$. Then, each G'_i contains a feedback vertex set S_i of size $\leq k_i$ and $S = \cup_{i=1}^q S_i$ is a feedback vertex set of J of size at most k .

Case 2. $e = \{v_0, v_q\}$ and $J = G / e$. As each G_i is typical, it should contain a feedback vertex set S_i of size $k_i + 1$ where $v_{i-1}, v_i \in S_i$. Notice that $S = \cup_{i=1}^q S_i$ is a feedback vertex set of G of size $(\sum_{i=1}^q (k_i + 1)) - (q - 1) = k + 1$, where $v_0, v_q \in S$. Then, after the contraction of $e = \{v_0, v_q\}$ to a single vertex v_e , the set $S^* = (S \cup \{v_e\}) \setminus \{v_0\} \setminus \{v_q\}$ is a feedback vertex set of J of size k .

Case 3. $e = \{v_{i-1}, v_i\}$ for some $i \in \{1, \dots, q\}$ and $J = G \setminus e$. Notice that $G_i \setminus e$ has a feedback vertex set S_i of size $\leq k_i$, therefore, S is also a feedback vertex set of $G'_i \setminus e$ that meets every path from v_{i-1} to v_i in G'_i . Let S_j now be a feedback vertex set of G'_j of size k_j for $j \in \{1, \dots, q\} - \{i\}$. Notice that $S = \cup_{j=1}^q S_j$ intersects all cycles that are entirely in G'_j for each $j = 1, \dots, q$. Moreover, each other cycle L will meet the vertices v_{i-1} and v_i and thus $L \cap (G'_i \setminus e)$ is a path in $G'_i \setminus e$ from v_{i-1} to v_i that is also intersected by $S_i \subseteq S$. Therefore S is a feedback vertex set of G of size at most $k_1 + \dots + k_q = k$.

Case 4. $e = \{v_{i-1}, v_i\}$ for some $i \in \{1, \dots, q\}$ and $J = G / e$. As $G'_i \in \mathbf{obs}(\mathcal{F}_{k_i})$, and G'_i is typical, it contains a feedback vertex set S of size $k + 1$ where $v_{i-1}, v_i \in S$. Let $G_i^* = G'_i / e$ and let v_e be the result of the contraction of e . Then $S^* = (S \cup \{v_e\}) \setminus \{v_{i-1}, v_i\}$ is a feedback vertex set of G_i^* of size k_i containing the vertex v_e . Let S_j now be a feedback vertex set of G'_j of size k_j for $j \in \{1, \dots, q\} - \{i\}$. Notice that $S = \cup_{j=1}^q S_j$ intersects all cycles that are entirely in $G'_1, \dots, G'_{i-1}, G_i^*, G'_{i+1}, \dots, G_q$ and each other cycle (if it exists) will contain v_e . Therefore, S is a feedback vertex set of G of size at most $k_1 + \dots + k_q = k$.

Case 5. e is an edge not in the central cycle of G . Let $e \in G'_i$ for some $i \in \{1, \dots, q\}$. Then, both $G_i \setminus e$ and G_i / e have a feedback vertex set S_i of size $\leq k_i$ that contains one of the vertices v_{i-1}, v_i and the same holds for any graph G_i^* in $\{G'_i \setminus e, G'_i / e\}$. Let S_j now be a feedback vertex set of G'_j of size k_j for $j \in \{1, \dots, q\} - \{i\}$. Notice that $S = \cup_{j=1, \dots, q} S_j$ intersects all cycles that are entirely in $G'_1, \dots, G'_{i-1}, G_i^*, G'_{i+1}, \dots, G_q$ and each other cycle will contain either v_{i-1} or v_i . Therefore, S is a feedback vertex set of G of size at most $k_1 + \dots + k_q = k$. \square \square

Observe that A_{2k+1} is a typical graph and a member of $\mathbf{obs}(\mathcal{F}_k)$, $k \geq 1$. Therefore, the definition of \mathcal{C}_k , the fact that all graphs in \mathcal{C}_k are outerplanar, and Lemma 3 implies the following.

Corollary 4. For every positive integer k , $\mathbf{obs}(\mathcal{F}_k) \cap \mathcal{D} \supseteq \mathcal{C}_k$.

3.2. $\mathbf{obs}(\mathcal{F}_k) \cap \mathcal{D} \subseteq \mathcal{C}_k$

In this section we mainly deal with biconnected outerplanar graphs. An edge of a biconnected outerplanar graph is a *simplicial edge* if at least one of its endpoints has degree two, an edge is a *separating edge* if its endpoints form a separator and an edge is a *side-edge* if it does not have a simplicial or separating edge.

Lemma 5 ([4]). *Let G be a connected graph in $\mathbf{obs}(\mathcal{F}_k)$. Then G is biconnected.*

We also need the following two easy observations.

Observation 6. *Let G be a graph containing a vertex v adjacent with exactly two non-adjacent vertices x, y . Then $\mathbf{fvs}(G) = \mathbf{fvs}(G/\{v, x\})$.*

Observation 7. *Let G be a connected graph and let e be an edge such that $G \setminus e$ has two connected components, G_1 and G_2 (i.e. e is a bridge). Then $\mathbf{fvs}(G) = \mathbf{fvs}(G_1) + \mathbf{fvs}(G_2)$.*

Lemma 8. *Let G be a graph in $\mathbf{obs}(\mathcal{F}_k) \cap \mathcal{D}$. Then none of the faces of G are incident to more than one side-edge.*

Proof. Suppose that G contains a face F incident to two side edges e_1 and e_2 . Clearly, F is not an extremal face. From **Observation 6**, e_1 and e_2 do not share common endpoints. Therefore we may assume that $e_1 = \{a, b\}$, $e_2 = \{c, d\}$, such that the sets $\{a, c\}$ and $\{b, d\}$ are both separators of G .

Since $G \in \mathbf{obs}(\mathcal{F}_k)$, $\mathbf{fvs}(G \setminus e) \leq k$. Let G_1 and G_2 be the two connected components of $G \setminus e_1 \setminus e_2$ and assume that $a, c \in V(G_1)$ and $b, d \in V(G_2)$. Let $\mathbf{fvs}(G_i) = k_i$, $i = 1, 2$. Then $k = \mathbf{fvs}(G \setminus e_1) = k_1 + k_2$ (by **Observation 7**). Let S_i be a feedback vertex set of G_i where $|S_i| \leq k$, $i = 1, 2$. Notice that $a, c \notin S_1$ and $b, d \notin S_2$ (otherwise, S would be a feedback vertex set of G). Therefore, every feedback vertex set of G_1 that contains some of a, c will have cardinality at least $k_1 + 1$ and every feedback vertex set of G_2 that contains some of b, d will have cardinality at least $k_2 + 1$.

Let S be a feedback vertex set of G / e_1 . Then $|S| \leq k$ and S should contain at least one of v_{ab}, c, d (we denote by v_{ab} the result of the contraction of $e_1 = \{a, b\}$). Notice that $v_{ab} \in S$, otherwise S would also be a feedback vertex set of G . As $S \cap V(G_1)$ is a feedback vertex set of G_1 that contains v_{ab} , we have that $|S \cap V(G_1)| \leq k_1 + 1$. Symmetrically, $|S \cap V(G_2)| \leq k_2 + 1$. We conclude that $|S| = |(S \cap V(G_1)) \cup (S \cap V(G_2))| = |S \cap V(G_1)| + |S \cap V(G_2)| - \{v_{ab}\} \geq k_1 + 1 + k_2 + 1 - 1 \geq k + 1$, a contradiction. \square

Lemma 9. *The only graph in $\mathbf{obs}(\mathcal{F}_k) \cap \mathcal{D}$ without side-edges is A_{2k+1} .*

Proof. Let $G \in \mathbf{obs}(\mathcal{F}_k) \cap \mathcal{D}$. From **Observation 6** all the edges incident to the outer face of G are simplicial, therefore G has an even number of vertices. This permits us to consider a cyclic ordering $(u_0, v_0, \dots, u_{q-1}, v_{q-1})$ where u_i is a simplicial vertex for $i = 0, \dots, q - 1$. This is also the cyclic ordering of the vertices of G in the outer face of G . Let also C be the cycle of G , where $E(C) = \{\{v_{p-1}, v_p\} \mid p = 0, \dots, q - 1\}$ (throughout this proof, we take all indices modulo q). Let

$$F = \{\{u_i, v_{i-1}\}, \{u_i, v_i\}, \{v_{i-1}, v_i\} \mid i = 0, \dots, q - 1\}.$$

It is enough to prove that $E(G) = F$. Suppose on the contrary that $E(G) \setminus F \neq \emptyset$. Let H be the subgraph of G induced by the edges in F . Clearly, H is not an edgeless graph. Notice that H is outerplanar and we may assume that $q \geq 5$ (recall that $\mathbf{obs}(\mathcal{F}_1) \cap \mathcal{D} = \{A_3\}$). We first claim that H is bridgeless. Suppose on the contrary that $e = \{v_i, v_j\}$ is a bridge of H (assuming $|i - j| \geq 2$). Then e is incident to two faces, namely F_1, F_2 , of G such that for $h = 1, 2$, each of F_h is incident to some, say f_h edge in C . Let S be a feedback vertex set of $G' = G \setminus e$ where $|S| \leq k$ and notice that in G' one of the endpoints of f_h , call it x_h , will belong to S , $h = 1, 2$. But then, S will also be a feedback vertex set of G as the cycle in the boundary of F_i contains $x_h \in S$, $h = 1, 2$, a contradiction and the claim follows.

As H is bridgeless, it contains at least one face that is not its outer-face. Among them, let F be one containing an edge $e = \{v_i, v_j\}$ (assuming $|i - j| \geq 2$) such that exactly one of the sets

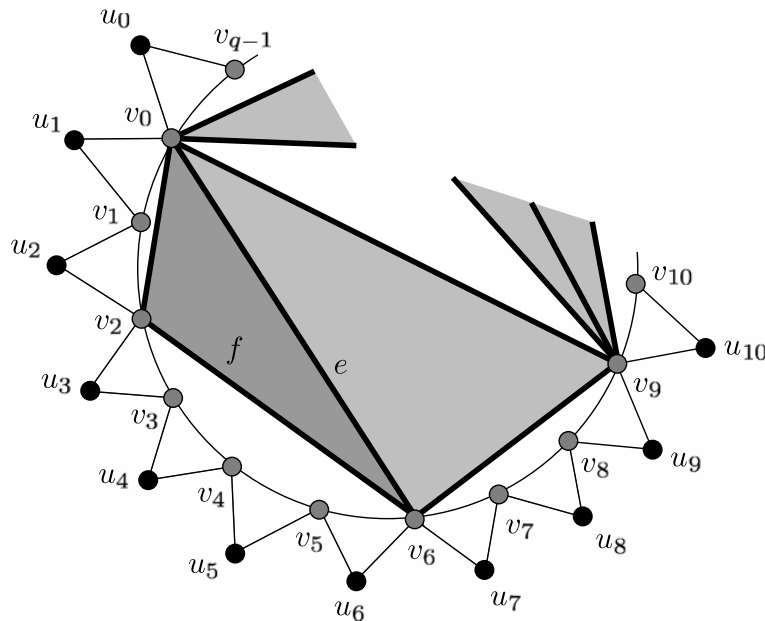

Fig. 2. The graph G and its (bridgeless) subgraph H (the edges of H are bold). The graph M is the one induced by the vertices $v_0, \dots, v_6, u_1, \dots, u_6$ and belongs in $\mathbf{obs}(\mathcal{F}_3)$.

$\{v_i, v_{i+1}, \dots, v_{j-1}, v_j\} \cap V(H)$ and $\{v_i, v_{i-1}, \dots, v_{j+1}, v_j\} \cap V(H)$ contains exactly the vertices incident to F . Without loss of generality we may assume that $1 \leq i < j$ and that F is incident to vertices in v_i, \dots, v_j .

Let f be an edge incident to F that is different from that e . We claim that the path P in C connecting the endpoints of f and avoiding the endpoints of e has even length. Suppose, on the contrary that P has length $2l + 1$, $l \geq 1$. Assume that $V(P) = \{x_1, \dots, x_{2l+2}\} \subseteq \{v_0, \dots, v_{q-1}\}$. Let $G' = G \setminus f$ and let S be a feedback vertex set of G' where $|S| \leq k$. Notice that $f \cap S = \emptyset$, otherwise S is also a feedback vertex set of G . Then, in order to cover all triangles of G containing edges of P one needs at least $\lceil \frac{2l+1}{2} \rceil = l + 1$ vertices, therefore $|S \cap V(P)| \geq l + 1$. But then $S' = S \setminus V(P) \cup \{x_1, x_3, \dots, x_{2l+1}\}$ is also a feedback vertex set of G' of size $\leq k$. As S contains one of the endpoints of f , S' is a feedback vertex set of G , a contradiction and the claim holds (Fig. 2).

Let $M = G[\{v_i, \dots, v_j\} \cup \{u_{i+1}, \dots, u_j\}]$. By the above claim and Lemma 3, $M \in \mathbf{obs}(\mathcal{F}_{k'})$ where $k' = \frac{j-i}{2}$ (recall that $j - i$ is even). Let $G' = G \setminus \{v_i, v_{i-1}\}$ and let S be a feedback vertex set of G' where $|S| \leq k$. Let also $S' = S \cap V(M)$. As $M \in \mathbf{obs}(\mathcal{F}_{k'})$, $|S'| \geq k' + 1$. Moreover, since M is typical, there is a feedback vertex set S^* of M such that $|S^*| = k' + 1$ and $v_i, v_j \in S^*$. Then $S'' = (S \setminus S') \cup S^*$ is also a feedback vertex set of G' of size at most k . As S'' contains v_i , it is also a feedback vertex set of G , a contradiction and this completes the proof that H is edgeless.

We conclude that G is isomorphic to A_q . Since $A_{3+2k} \in \mathbf{obs}(\mathcal{F}_{1+k})$, and $A_{2+2k} \notin \mathbf{obs}(\mathcal{F}_k)$ (because A_{1+2k} is a minor of A_{2+2k}), then $q = 1 + 2k$ and therefore G is isomorphic to A_{1+2k} . \square

Lemma 10. Let k be a positive integer, let $G \in \mathbf{obs}(\mathcal{F}_k) \cap \mathcal{D}$ containing a side edge $e = \{v_0, v_q\}$ and let G_i , $i = 1, \dots, q$ be graphs such that $G \in \Delta(G_1, \dots, G_q)$ in a way that e belongs in the central cycle C of G . Then $G_i \in \mathbf{obs}(\mathcal{F}_{k_i})$, $i = 1, \dots, q$ where $\sum_{i=1, \dots, q} k_i = k$.

Proof. For $i = 1, \dots, q$, let $k_i = \mathbf{fvs}(G_i) - 1$. We claim that $\sum_{i=1, \dots, q} k_i = k$. The fact that $\sum_{i=1, \dots, q} k_i \geq k$ follows immediately from Lemma 2. For the inverse inequality, notice first that $\mathbf{fvs}(G \setminus e) \leq k$ and let S be a feedback vertex set of $G \setminus e$ with size $\leq k$. Clearly, $V(C) \cap S = \emptyset$, otherwise S would also be a feedback vertex set of G . For $i = 1, \dots, q$, we define $S_i = S \cap V(G'_i)$ and we observe that $\sum_{i=1}^q |S_i| = |S| = k$. As S_i meets all cycles of G'_i (as appearing in the definition of Δ) and thus $S_i \cup \{v_i\}$ is a feedback vertex set of G_i . This implies that $k_i + 1 = \mathbf{fvs}(G_i) \leq |S_i| + 1$, $i = 1, \dots, q$ therefore $\sum_{i=1}^q k_i \leq \sum_{i=1}^q |S_i| = |S| = k$ and the claim holds.

It now remains to prove that for any G_i , $i = 1, \dots, q$, the removal or the contraction of every edge in G_i results in a graph H_i where $\mathbf{fvs}(H_i) \leq k_i$. From Observations 6 and 7, the removal or contraction

of each edge of G_i that is incident to u_i (again as in the definition of \triangleleft) results in a graph J where $\mathbf{fvs}(J) = \mathbf{fvs}(G_i \setminus \{v_{i-1}, v_i\})$. Therefore we may assume that f is also an edge of G'_i and an edge of G as well. We distinguish the following cases.

Case 1. f is an edge of G_i but not in C . Suppose on the contrary that $\mathbf{fvs}(H_i) \geq k_i + 1$. Then observe that $H = \triangleleft(G_1, \dots, G_{i-1}, H_i, G_{i+1}, G_q)$ is a proper minor of G , therefore $\mathbf{fvs}(H) \leq k$, a contradiction as, by Lemma 2, $\mathbf{fvs}(H) \geq 1 + \sum_{i=1}^q k_i = k + 1$.

Case 2. $f = \{v_{i-1}, v_i\}$ and $H_i = G_i \setminus f$. Recall that $\mathbf{fvs}(H_i) = \mathbf{fvs}(G'_i)$ (from Observation 6). Let S be a feedback vertex set of $G \setminus e$. Set $S_j = S \cap V(G'_j)$, $j = 1, \dots, q$. Recall that $k = \sum_{i=1}^q k_i$ and $V(C) \cap S = \emptyset$. Moreover, S_j is a feedback vertex set of G'_j , $j = 1, \dots, q$, thus $|S_j| \geq k_j$, $j = 1, \dots, q$. Therefore $k \geq |S| = \sum_{i=1}^q |S_i| = (\sum_{j=1, \dots, i-1, i+1, \dots, q} |S_j|) + |S_i| \geq (\sum_{j=1, \dots, i-1, i+1, \dots, q} k_j) + |S_i| \Rightarrow |S_i| \leq k_i$. As S_i is a feedback vertex set of G'_i we conclude $\mathbf{fvs}(H_i) = \mathbf{fvs}(G'_i) \leq k$ as required.

Case 3. $f = \{v_{i-1}, v_i\}$ and $H_i = G_i / f$. From Observation 7, $\mathbf{fvs}(G_i / f) = \mathbf{fvs}(G'_i / f)$. Notice that G'_i / f is a minor of $G_i \setminus f$ that has a feedback vertex set of size $\leq k_i$ as proved in the previous case. \square

From Lemmas 9 and 10 we obtain the following.

Corollary 11. For every positive integer k , $\mathbf{obs}(\mathcal{F}_k) \cap \mathcal{D} \subseteq \mathcal{C}_k$.

The following result characterizes all disconnected members of $\mathbf{obs}(\mathcal{F}_k)$ and follows from the results of [3].

Proposition 12. Let G_1, \dots, G_l be the connected components of some graph G . Then $G \in \mathbf{obs}(\mathcal{F}_k)$ if and only if $G_i \in \mathbf{obs}(\mathcal{F}_{k_i})$, $i = 1, \dots, l$ where $k = \sum_{i=1}^l k_i$.

To conclude this section, Theorem 1 follows directly from Corollaries 4 and 11 and Proposition 12.

4. Enumeration

In this part we find asymptotic estimates for $|\mathcal{C}_k|$ and $|\mathcal{Y}_k|$. The basic tools in this section are the Symbolic Method and the singularity analysis applied on generating functions, joined with the powerful Dissymmetry Theorem for trees. The main reference in this section is the reference book of Flajolet and Sedgewick [6].

4.1. Preliminaries for enumeration

The symbolic method. Let \mathcal{A} be a set of objects, and let $|\cdot|$ be an application from \mathcal{A} to \mathbb{N} . If $a \in \mathcal{A}$, we say that $|a|$ is the size of a . A pair $(\mathcal{A}, |\cdot|)$ is called a combinatorial class. We restrict ourselves to combinatorial classes where the number of elements with a prescribed size is finite (also called admissible combinatorial classes). Under this assumption, we define the formal power series $\mathbf{A}(z) = \sum_{a \in \mathcal{A}} z^{|a|} = \sum_{n=0}^{\infty} a_n z^n$, and conversely, $[z^n] \mathbf{A}(z) = a_n$. We say that $\mathbf{A}(z)$ is the generating function (or shortly the GF) associated to the combinatorial class $(\mathcal{A}, |\cdot|)$. We can consider also additional parameters over \mathcal{A} . In this case, the corresponding GF is a multivariate generating function. The symbolic method is a tool that provides a systematic method to translate set conditions between combinatorial classes into algebraic conditions between GFs.

Basic classes and constructions. Restricted constructions. We introduce here the basic classes and combinatorial constructions, as well as their translation into the GF language. The neutral class \mathcal{E} is made of a single object of size 0, and its GF is $\mathbf{e}(z) = 1$. The atomic class \mathcal{Z} is made of a single object of size 1, and its associated GF is $\mathbf{Z}(z) = z$. The union $\mathcal{A} \cup \mathcal{B}$ of two classes \mathcal{A} and \mathcal{B} refers to the disjoint union of the classes (and the corresponding induced size). The Cartesian product $\mathcal{A} \times \mathcal{B}$ of two classes \mathcal{A} and \mathcal{B} is the set of pairs (a, b) where $a \in \mathcal{A}$ and $b \in \mathcal{B}$. The size of (a, b) is the sum of the sizes of a and b . The sequence of a set \mathcal{A} (denoted by $\text{Seq}(\mathcal{A})$) is the set $\mathcal{E} \cup \mathcal{A} \cup (\mathcal{A} \times \mathcal{A}) \cup (\mathcal{A} \times \mathcal{A} \times \mathcal{A}) \cup \dots$. The multiset construction $\text{Mul}(\mathcal{A})$ is $\text{Seq}(\mathcal{A}) / \sim$, where $(a_1, a_2, \dots, a_r) \sim (\widehat{a}_1, \widehat{a}_2, \dots, \widehat{a}_r)$ if and only if there exists a permutation of indices τ in $\{1, \dots, r\}$ such that the equality $a_i = \widehat{a}_{\tau(i)}$ holds for all i .

Table 1

The translation of combinatorial specifications into algebraic conditions using the Symbolic Method. In the table, GFs associated to classes \mathcal{A} and \mathcal{B} are $\mathbf{A}(z)$ and $\mathbf{B}(z)$, respectively.

Construction		Generating function
Union	$\mathcal{A} \cup \mathcal{B}$	$\mathbf{A}(z) + \mathbf{B}(z)$
Product	$\mathcal{A} \times \mathcal{B}$	$\mathbf{A}(z) \cdot \mathbf{B}(z)$
Sequence	$\text{Seq}(\mathcal{A})$	$(1 - \mathbf{A}(z))^{-1}$
Multiset	$\text{Mul}_{>0}\mathcal{A}$	$\exp(\sum_{r=1}^{\infty} \frac{1}{r} \mathbf{A}(z^r)) - 1$
Cycle	$\text{Cyc}(\mathcal{A})$	$\sum_{d=1}^{\infty} \frac{\varphi(d)}{d} \log \frac{1}{1 - \mathbf{A}(z^d)}$

The *proper* multiset construction $\text{Mul}_{>0}\mathcal{A}$ refers to the subset of $\text{Mul}(\mathcal{A})$ where all elements have size greater than 0. Similarly, the cycle construction $\text{Cyc}(\mathcal{A})$ is defined as $\text{Cyc}(\mathcal{A}) = \text{Seq}(\mathcal{A}) / \sim$, where $(a_1, a_2, \dots, a_r) \sim (\widehat{a}_1, \widehat{a}_2, \dots, \widehat{a}_r)$ if and only if there exists a circular shift ζ in $\{1, \dots, r\}$ such that the equality $a_i = \widehat{a}_{\zeta(i)}$ holds for each i . The size of an element (a_1, \dots, a_s) of either $\text{Seq}(\mathcal{A})$, $\text{Mul}(\mathcal{A})$ or $\text{Cyc}(\mathcal{A})$ is the sum of sizes of the elements a_i . The translation of these constructions into GFs is summarized in Table 1. The details can be found in [6].

We need to deal with *restricted constructions*. Let $\Omega \subseteq \mathbb{N}$, and consider the restricted operator $\text{Seq}_{\Omega}(\mathcal{A})$, which is defined as $\text{Seq}_{\Omega}(\mathcal{A}) = \bigcup_{r \in \Omega} \mathcal{A} \times \dots \times \mathcal{A}$. This operator induces operators Cyc_{Ω} and Mul_{Ω} . The particular case $\Omega = \{r, r + k, r + 2k, \dots\}$ is denoted by $\Omega = r + k\mathbb{N}$. If $k = 0$, the GF associated to $\text{Cyc}_{\{r\}}(\mathcal{A})$ is $\mathbf{B}_r(z)$, with expression

$$\mathbf{B}_r(z) = [v^r]\mathbf{B}(z, v) = [v^r] \sum_{d=1}^{\infty} \frac{\varphi(d)}{d} \log \frac{1}{1 - v^d \mathbf{A}(z^d)}.$$

For multivariate GFs, we write $\mathbf{z} = (z_1, z_2, \dots, z_s)$ and denote by \mathbf{z}^l the vector $(z_1^l, z_2^l, \dots, z_s^l)$. Then, if $\mathbf{A}(\mathbf{z})$ is a multivariate GF associated to \mathcal{A} , then the construction $\text{Cyc}_{\{r\}}(\mathcal{A})$ gives rise to

$$\mathbf{B}_r(\mathbf{z}) = [v^r]\mathbf{B}(\mathbf{z}, v) = [v^r] \sum_{d=1}^{\infty} \frac{\varphi(d)}{d} \log \frac{1}{1 - v^d \mathbf{A}(\mathbf{z}^d)}. \tag{1}$$

Let \mathcal{A} be a combinatorial class of graphs whose elements are embedded in the plane, such that it is closed by mirror symmetries (or reflections) of the plane. Let $\mathbf{A}(\mathbf{z})$ be its GF. For each element g in \mathcal{A} we denote by g^* the element which is obtained from g by a reflection. Elements in \mathcal{A} which are invariant under reflections are called *symmetric* elements. We define a new class

$$\mathcal{A}^* = \{(g, g^*) : g, g^* \in \mathcal{A}, g^* \text{ is the reflection of } g\}.$$

It is obvious then that the multivariate GF associated to \mathcal{A}^* is $\mathbf{A}^*(\mathbf{z}) = \mathbf{A}(\mathbf{z}^2)$.

Singularity analysis of generating functions. Once we know the conditions that a GF satisfies, we are interested in saying how its coefficients grow. This information can be obtained by considering GFs as complex analytic functions in a neighborhood of the origin. The growth behavior of coefficients is related to the smallest singularity of the GF. These GFs have positive coefficients, hence Pringsheim's Theorem [6] asserts that their smallest singularity are non-negative real numbers. The *location* of this singularity provides the *exponential growth* of the coefficients, and the *behavior* of the singularity provides the *subexponential growth* of the coefficients.

The main results in this part are the so-called *Transfer Theorems of singularity analysis*. These results allow us to deduce asymptotic estimates of an analytic function using its asymptotic expansion near its dominant singularity. The precise statement is claimed in [6] (based on the seminal paper [5]). Roughly speaking, the statement is the following: let $\mathbf{F}(u)$ be a GF with positive coefficients, such that ρ is its unique smallest real singularity. Let α be a non-negative integer. Suppose that $\mathbf{F}(u)$ admits a singular expansion around $u = \rho$ of the form $\mathbf{F}(u) = f(1 - u/\rho)^{-\alpha} + O((1 - u/\rho)^{-\alpha})$, where f is a constant. Then,

$$[u^k]\mathbf{F}(u) = f \frac{k^{\alpha-1}}{\Gamma(\alpha)} \rho^{-k} (1 + O(k^{-1})). \tag{2}$$

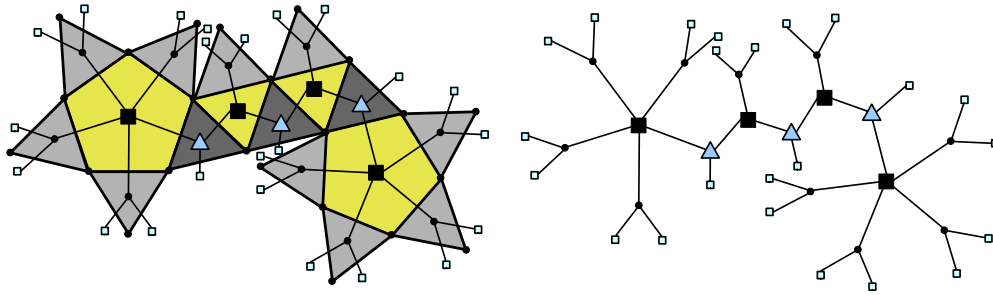

Fig. 3. One element of the family and the associated tree. Danglings correspond to vertices of type \square .

The Dissymmetry Theorem for Trees. The Dissymmetry Theorem for Trees [1] provides a method to express a combinatorial class of unrooted trees in terms of related classes of rooted trees. More concretely, let \mathcal{T} be a class of unrooted trees. We define the following families of rooted trees: \mathcal{T}_\circ is built from \mathcal{T} by pointing a vertex, $\mathcal{T}_{\circ-\circ}$ is the class of trees in \mathcal{T} where an edge is pointed and $\mathcal{T}_{\circ\rightarrow\circ}$ is the class of trees in \mathcal{T} where an oriented edge is pointed. The Dissymmetry Theorem for Trees asserts that

$$\mathcal{T} \cup \mathcal{T}_{\circ\rightarrow\circ} \simeq \mathcal{T}_{\circ-\circ} \cup \mathcal{T}_\circ,$$

where “ \simeq ” means that the two combinatorial classes are combinatorially isomorphic (i.e., the number of elements with a prescribed size in each combinatorial class is the same).

4.2. Tree decomposition, enumeration and asymptotic counting

In order to get precise enumerative estimates, we start constructing a bijection between elements in $\mathcal{C} = \bigcup_{k \geq 1} \mathcal{C}_k$ and a class of unrooted trees which are embedded in the plane (1-face maps). Using the Dissymmetry Theorem we obtain the corresponding GF, and we deduce the GF for the family $\mathcal{Y} = \bigcup_{k \geq 1} \mathcal{Y}_k$. At the end, singularity analysis over the resulting GFs gives the growth behavior of its coefficients, which is of the form $O(k^{-5/2} \rho^{-k})$, typical in unrooted tree-like structures.

4.2.1. A bijection with a family of embedded trees

We start introducing some terminology. Let G be a graph in \mathcal{C} . From now on, we make an abuse of notation writing G for the map which is defined when G is embedded in the plane, in such a way that all vertices of G are incident with the unbounded face (or infinite face). We denote the infinite face by c_∞ . All elements in \mathcal{C} are unrooted dissections, and consequently, this embedding is defined up to reflections. Faces defined by simplicial triangles are called *teeth faces*, and faces defined by central cycles are called *central faces*. The remaining faces (which correspond with the center of gears) are called *gear faces*.

Every map G defines the dual map G^* in the usual way: we draw a vertex of G^* in each face of G and an edge of G^* across each edge of G . Let v_∞ be the vertex in G^* associated to c_∞ . Consider the map g obtained by splitting this vertex. The new vertices obtained from this one have degree 1, and we call them the *danglings* of g . The *level of obstruction* of g is the level of obstruction of the graph it comes from. Using induction on the number of vertices of G , it is clear that g is an embedded tree (equivalently, a 1-face map on the sphere), and if G has n vertices, then g has n danglings. From now on, we call g the *tree associated* to G . Vertices in the associated tree are called *teeth vertices*, *central vertices* and *gear vertices*, depending on the type of the face they come from. Graphically, we use the symbols \blacksquare for gear vertices, \triangle for central vertices and \bullet for teeth vertices. Danglings are represented using a white square of the form \square . An example of this construction of g from G and the different types of vertices is shown in Fig. 3.

The specifications for this type of trees are the following ones:

1. Vertices of type \blacksquare have odd degree greater or equal than three, and they are joined either to \bullet -vertices or \triangle -vertices.

2. Vertices of type Δ have degree greater or equal than three. Every vertex of this type is joined to exactly one dangling.
3. Vertices of type \bullet have degree three and they are joined to two danglings and a \blacksquare -vertex.

All these trees must be counted up to reflections. We denote by \mathcal{M} the set of all embedded trees with the previous properties, and $\mathcal{T} = \mathcal{M}/\lambda$, where $m_1 \lambda m_2$ if and only if m_1 is obtained from m_2 by a reflection. It is obvious that every tree in \mathcal{T} defines a graph in \mathcal{C} . As a consequence, there is a bijection between \mathcal{C} and \mathcal{T} . Resuming, our problem has been translated into the problem of counting the number of trees in \mathcal{T} with a fixed level of obstruction. As we show later, this problem is simplified to the problem of counting the elements in \mathcal{M} .

4.2.2. Getting the GF

In the following discussion z counts danglings and u counts the level of obstruction. Let $\mathbf{T}(z, u) = \sum_{n,k>0} t_{n,k} z^n u^k$ be the bivariate GF associated to \mathcal{T} , where $t_{n,k}$ is the number of trees in \mathcal{T} with exactly n danglings and level of obstruction equal to k . Recall that all trees in \mathcal{T} are unrooted and counted up to reflection. We use the Dissymmetry Theorem to express this class in terms of related rooted trees.

Let us define some extra combinatorial classes. Let \mathcal{T}_Δ be the class of trees obtained from \mathcal{T} by pointing a central vertex. Denote by $\mathbf{T}_\Delta(z, u)$ the associated GF. Similar definitions are made for the classes \mathcal{T}_\blacksquare , $\mathcal{T}_{\Delta-\blacksquare}$, $\mathcal{T}_{\blacksquare \rightarrow \Delta}$ and $\mathcal{T}_{\Delta \rightarrow \blacksquare}$. The same definitions are done on class \mathcal{M} . The application of the Dissymmetry Theorem provides the following lemma:

Lemma 13. *There exists the following combinatorial isomorphisms between combinatorial classes:*

$$\begin{aligned} \mathcal{T} \cup \mathcal{T}_{\Delta \rightarrow \blacksquare} \cup \mathcal{T}_{\blacksquare \rightarrow \Delta} &\simeq \mathcal{T}_{\Delta-\blacksquare} \cup \mathcal{T}_\blacksquare \cup \mathcal{T}_\Delta, \\ \mathcal{M} \cup \mathcal{M}_{\Delta \rightarrow \blacksquare} \cup \mathcal{M}_{\blacksquare \rightarrow \Delta} &\simeq \mathcal{M}_{\Delta-\blacksquare} \cup \mathcal{M}_\blacksquare \cup \mathcal{M}_\Delta. \end{aligned} \tag{3}$$

Proof. Let $g \in \mathcal{T}$ be a tree, and let r be its center. The center of a tree defines a canonical rooting on the tree, which can be either a vertex or an edge. In fact, $r \in \{\blacksquare, \Delta, \blacksquare-\Delta\}$. In other words, neither a dangling nor a tooth vertex belongs to the center of g . To obtain relation (3), we apply the Dissymmetry Theorem, taking only valid choices of the canonical root. The same argument holds for class \mathcal{M} . \square

The next step consists of translating Eq. (3) into the language of generating functions. Applying the Symbolic Method we get

$$\mathbf{T}(z, u) = \mathbf{T}_{\Delta-\blacksquare}(z, u) + \mathbf{T}_\blacksquare(z, u) + \mathbf{T}_\Delta(z, u) - \mathbf{T}_{\Delta \rightarrow \blacksquare}(z, u) - \mathbf{T}_{\blacksquare \rightarrow \Delta}(z, u), \tag{4}$$

which can be reduced up to $\mathbf{T}(z, u) = \mathbf{T}_\blacksquare(z, u) + \mathbf{T}_\Delta(z, u) - \mathbf{T}_{\Delta-\blacksquare}(z, u)$ (orientation of edges is superfluous, because end-vertices have different nature).

We obtain each term in the right hand side separately using the following observation: each element in \mathcal{M} is either invariant under reflections or not. Elements which are not invariant under reflections are counted twice (each tree of this type has two representatives in \mathcal{M} , and one representative in \mathcal{T}), and the ones which are invariant are counted once. Denote the type of root by \star , and let $\mathcal{S}_\star \subseteq \mathcal{M}_\star$ be the set of elements of \mathcal{M}_\star which are invariant under reflections. Let $\mathbf{M}_\star(z, u)$, $\mathbf{S}_\star(z, u)$ be the GFs of trees in \mathcal{M}_\star and \mathcal{S}_\star , respectively. Then it is clear from the previous observation that

$$\mathbf{T}_\star(z, u) = \frac{1}{2}(\mathbf{M}_\star(z, u) + \mathbf{S}_\star(z, u)), \tag{5}$$

where z marks vertices and u codifies the level of obstruction.

Mobiles and symmetric mobiles. We need to introduce auxiliary classes of rooted trees, that we call *mobiles*. We call these families \blacksquare -mobiles and Δ -mobiles (depending on the type of the root), which are represented by $\vec{\mathcal{M}}_\blacksquare$ and $\vec{\mathcal{M}}_\Delta$, respectively. Let $\vec{\mathbf{M}}_\blacksquare(z, u)$ and $\vec{\mathbf{M}}_\Delta(z, u)$ be the corresponding GFs. We define each family in terms of elements of the other class. Let $\vec{\mathcal{M}}_\blacksquare$ be the class of rooted trees on a vertex of type \blacksquare with an even number of sons, that are either Δ -mobiles or \bullet -vertices. Reciprocally,

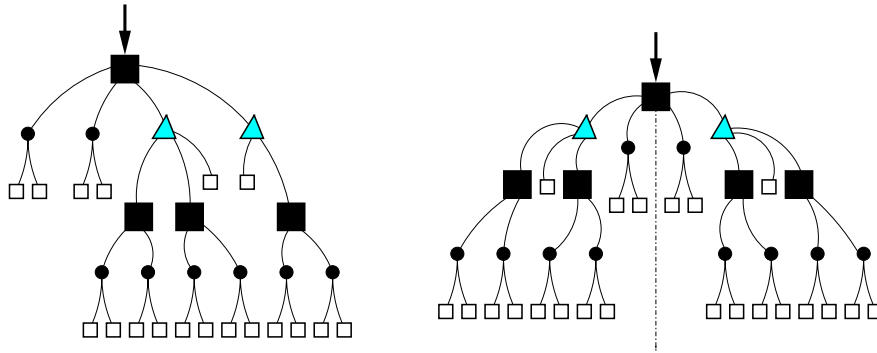

Fig. 4. A ■-mobile and a symmetric ■-mobile.

the family $\vec{\mathcal{M}}_{\Delta}$ is the class of rooted trees on a vertex of type Δ whose sons are $k > 0$ ■-mobiles and a unique dangling. We define also the auxiliary class

$$\mathcal{B} = \{(\square, \square)\} \cup \vec{\mathcal{M}}_{\Delta}, \tag{6}$$

(with GF $\mathbf{B}(z, u) = z^2 + \vec{\mathbf{M}}_{\Delta}(z, u)$). From the previous considerations we deduce that $\vec{\mathcal{M}}_{\blacksquare} = \text{Seq}_{2+2\mathbb{N}}(\mathcal{B})$ (every vertex of type \bullet is connected to exactly two danglings and a gear vertex). Consequently $\vec{\mathbf{M}}_{\blacksquare}(z, u) = u\mathbf{B}(z, u)^2 + u^2\mathbf{B}(z, u)^4 + \dots = u\mathbf{B}(z, u)^2 / (1 - u\mathbf{B}(z, u)^2)$.

For Δ -mobiles, the relation is slightly different. For a Δ -mobile whose root has exactly k sons, there are k possibilities to choose the position of the unique dangling connected to the root. This observation gives the following relation:

$$\vec{\mathbf{M}}_{\Delta}(z, u) = z \sum_{k=2}^{\infty} k \vec{\mathbf{M}}_{\blacksquare}(z, u)^{k-1} = \frac{z}{(1 - \vec{\mathbf{M}}_{\blacksquare}(z, u))^2} - z.$$

These pair of equations define the following system of equations:

$$\vec{\mathbf{M}}_{\blacksquare}(z, u) = \frac{(z^2 + \vec{\mathbf{M}}_{\Delta}(z, u))^2 u}{1 - (z^2 + \vec{\mathbf{M}}_{\Delta}(z, u))^2 u}, \quad \vec{\mathbf{M}}_{\Delta}(z, u) = \frac{z}{(1 - \vec{\mathbf{M}}_{\blacksquare}(z, u))^2} - z,$$

which defines the following implicit expression for $\vec{\mathbf{M}}_{\blacksquare}(z, u)$:

$$\vec{\mathbf{M}}_{\blacksquare}(z, u) = \frac{(z^2 - z + z/(1 - \vec{\mathbf{M}}_{\blacksquare}(z, u))^2)^2 u}{1 - (z^2 - z + z/(1 - \vec{\mathbf{M}}_{\blacksquare}(z, u))^2)^2 u}. \tag{7}$$

We need to define subclasses of mobiles which are invariant under reflection (Fig. 4). We call these families *symmetric mobiles* of type ■ or Δ , depending on the type of the root. We denote these families by $\vec{\mathcal{S}}_{\blacksquare}$ and $\vec{\mathcal{S}}_{\Delta}$, and the corresponding GF by $\vec{\mathbf{S}}_{\blacksquare}(z, u)$ and $\vec{\mathbf{S}}_{\Delta}(z, u)$, respectively. For the family $\vec{\mathcal{S}}_{\blacksquare}$, the argument used to get the associated GF is quite similar to the one made for $\vec{\mathcal{M}}_{\blacksquare}$. In this case, $\vec{\mathcal{S}}_{\blacksquare} = \text{Seq}_{1+\mathbb{N}}(\mathcal{B}^*)$: we take a sequence of pairs of trees where one is the reflection of the other. In the case of $\vec{\mathcal{S}}_{\Delta}$, one must notice that the unique dangling connected to the root must belong to the symmetry axis of the reflection. Hence, a mobile of this type is an element in $\{\square\} \times \text{Seq}_{1+\mathbb{N}}(\vec{\mathcal{M}}_{\blacksquare}^*)$. These considerations give the equations

$$\vec{\mathbf{S}}_{\blacksquare}(z, u) = \frac{(z^4 + \vec{\mathbf{M}}_{\Delta}(z^2, u^2))u}{1 - (z^4 + \vec{\mathbf{M}}_{\Delta}(z^2, u^2))u}, \quad \vec{\mathbf{S}}_{\Delta}(z, u) = \frac{z \vec{\mathbf{M}}_{\blacksquare}(z^2, u^2)}{(1 - \vec{\mathbf{M}}_{\blacksquare}(z^2, u^2))}.$$

Edge-rooted families. All the discussion is made over the class $\mathcal{T}_{\blacksquare-\Delta}$. The same argument can be adapted for the rest of the edge-rooted families. The computation of $\mathbf{M}_{\blacksquare-\Delta}(z, u)$ is deduced from the obvious decomposition $\mathcal{M}_{\blacksquare-\Delta} \simeq \vec{\mathcal{M}}_{\blacksquare} \times \vec{\mathcal{M}}_{\Delta}$. We get the GF for $\mathbf{S}_{\blacksquare-\Delta}(z, u)$ from the following observation: if

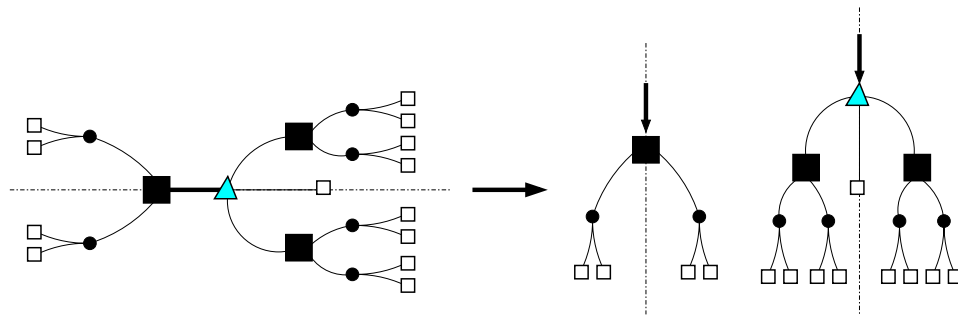

Fig. 5. A tree rooted at an edge of the form ■– Δ, and the decomposition into mobiles.

$m \in \mathcal{M}_{\blacksquare-\Delta}$ is equal to m^* , then the axis defined by the rooted edge is a symmetry axis, and a reflection respect to it leaves m invariant (see Fig. 5).

In other words, $\mathcal{M}_{\blacksquare-\Delta} \simeq \vec{\mathcal{M}}_{\blacksquare} \times \vec{\mathcal{M}}_{\Delta}$, and of $\mathcal{S}_{\blacksquare-\Delta} \simeq \vec{\mathcal{S}}_{\blacksquare} \times \vec{\mathcal{S}}_{\Delta}$. Summing up these contributions in the form stated in Eq. (5), we get

$$\mathbf{T}_{\blacksquare-\Delta}(z, u) = \frac{1}{2} (\vec{\mathbf{M}}_{\blacksquare}(z, u) \vec{\mathbf{M}}_{\Delta}(z, u) + \vec{\mathbf{S}}_{\blacksquare}(z, u) \vec{\mathbf{S}}_{\Delta}(z, u)). \tag{8}$$

The family \mathcal{T}_{Δ} . Pointing a vertex of the type Δ provides a canonical decomposition of trees in the following way: let $m \in \mathcal{M}_{\Delta}$, and let Δ^{\bullet} be the pointed Δ-vertex on m . This tree can be written as a sequence of ■-mobiles, with an ordering induced by the unique dangling connected to Δ^{\bullet} (for instance, in anticlockwise order around vertex Δ^{\bullet} starting at the distinguished dangling). In other words, $\mathcal{M}_{\Delta} \simeq \{\square\} \times \text{Seq}_{2+\mathbb{N}}(\vec{\mathcal{M}}_{\blacksquare})$.

To count symmetric Δ-rooted trees, notice that the unique dangling connected to the root defines an axis of symmetry, such that the tree remains invariant when a reflection is applied (in particular, using this axis as axis of symmetry). Consequently, $\mathcal{S}_{\Delta} \simeq \{\square\} \times (\mathcal{E} \cup \vec{\mathcal{S}}_{\blacksquare}) \times \text{Seq}_{1+\mathbb{N}}(\vec{\mathcal{M}}_{\blacksquare}^*)$, and the expression for $\mathbf{T}_{\Delta}(z, u)$ is the following one:

$$\mathbf{T}_{\Delta}(z, u) = \frac{1}{2} \left(z \frac{\vec{\mathbf{M}}_{\blacksquare}(z, u)^2}{1 - \vec{\mathbf{M}}_{\blacksquare}(z, u)} + z(1 + \vec{\mathbf{S}}_{\blacksquare}(z, u)) \frac{\vec{\mathbf{M}}_{\blacksquare}(z^2, u^2)}{1 - \vec{\mathbf{M}}_{\blacksquare}(z^2, u^2)} \right). \tag{9}$$

The family $\mathcal{T}_{\blacksquare}$. This case is more involved. It is immediate from the definition that $\mathcal{M}_{\blacksquare} = \text{Cyc}_{3+2\mathbb{N}}(\mathcal{B})$. To find the corresponding GF, we use relation (1) in the following way:

$$\begin{aligned} \mathbf{M}_{\blacksquare}(z, u) &= \sum_{k=1}^{\infty} \mathbf{B}_{1+2k}(z, u) u^k = \sum_{k=1}^{\infty} u^k [V^{1+2k}] \mathbf{B}(z, u, V) \\ &= \sum_{k=1}^{\infty} u^k [V^{1+2k}] \sum_{d=1}^{\infty} \frac{\varphi(d)}{d} \log \frac{1}{1 - V^d \mathbf{B}(z^d, u^d)}. \end{aligned}$$

To make this calculation, we compute the sum $\sum_{k=0}^{\infty} \mathbf{B}_{1+2k}(z, u) V^{1+2k}$, which is the odd part of the function $\mathbf{B}(z, u, V)$ with respect to V :

$$\begin{aligned} \sum_{k=0}^{\infty} \mathbf{B}_{1+2k}(z, u) V^{1+2k} &= \frac{\mathbf{B}(z, u, V) - \mathbf{B}(z, u, -V)}{2} \\ &= \frac{1}{2} \sum_{d=0}^{\infty} \frac{\varphi(1+2d)}{1+2d} \log \left(\frac{1 + V^{1+2d} \mathbf{B}(z^{1+2d}, u^{1+2d})}{1 - V^{1+2d} \mathbf{B}(z^{1+2d}, u^{1+2d})} \right). \end{aligned}$$

Then it is clear that writing $V = \sqrt{u}$ in the previous expression and dividing by \sqrt{u} gives the desired relation:

$$\mathbf{M}_{\blacksquare}(z, u) = \sum_{k=1}^{\infty} \mathbf{B}_{1+2k}(z, u) u^k = \frac{1}{2\sqrt{u}} (\mathbf{B}(z, u, \sqrt{u}) - \mathbf{B}(z, u, -\sqrt{u})) - \frac{1}{2} [V] \mathbf{B}(z, u, V)|_{V=\sqrt{u}}.$$

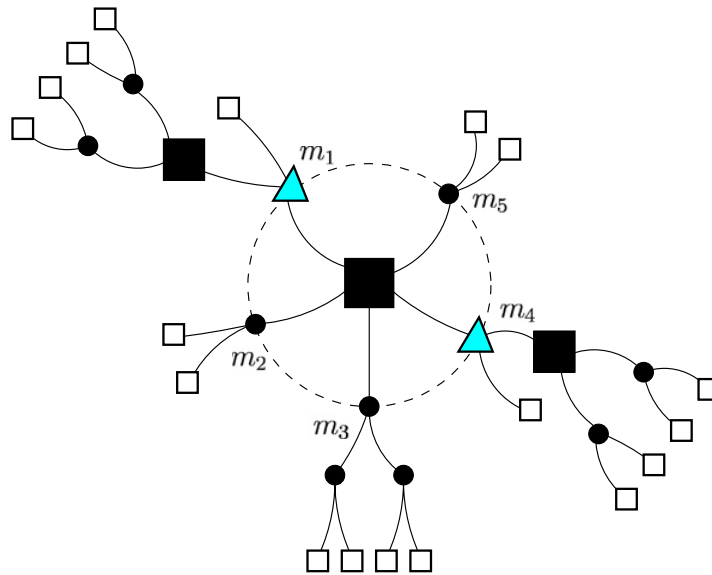

Fig. 6. An example, with the geometric circle and the geometric sons.

To conclude, notice that $[V]\mathbf{B}(z, u, V) = \frac{\partial}{\partial u}|_{V=0}\mathbf{B}(z, u, V) = \mathbf{B}(z, u)$, and consequently the expression of $\mathbf{M}_{\blacksquare}(z, u)$ in terms of $\mathbf{B}(z, u)$ is

$$\mathbf{M}_{\blacksquare}(z, u) = \frac{1}{2\sqrt{u}} \sum_{d=0}^{\infty} \frac{\varphi(1+2d)}{1+2d} \log \frac{1+u\sqrt{u}\mathbf{B}(z^{1+2d}, u^{1+2d})}{1-u\sqrt{u}\mathbf{B}(z^{1+2d}, u^{1+2d})} - \mathbf{B}(z, u). \tag{10}$$

Observe that $\mathbf{M}_{\blacksquare,1}(z, u)$ (as a complex function) is analytic at $u = 0$, despite the existence of the term \sqrt{u} (there is a cancelation of this square root when we obtain the Taylor development of this function around 0).

The next step consists of getting the GF $\mathbf{S}_{\blacksquare}(z, u)$: we need to study \blacksquare -rooted trees which are invariant up to reflection. We introduce some terminology to deal with this problem. Let $m \in \mathcal{S}_{\blacksquare}$. We suppose that vertices incident with the root of m are drawn over a circle centered at the root, describing the vertices of a regular polygon. We call this circle the *geometric circle* associated to m , and the sons of the root vertex of m (which are either roots of \triangle -mobiles or \bullet -vertices) are the *geometric sons*. We enumerate geometric sons using indices $1, 2, \dots, r$ in counterclockwise order. This enumeration induces a decomposition of m in a sequence of r rooted trees m_1, m_2, \dots, m_r . An example is shown in Fig. 6.

Let l_s be the line which passes through the root of m and the geometric son s . Let π_s be the reflection respect to this line. This symmetry transforms the sequence of trees $m_1, \dots, m_{s-1}, m_s, m_{s+1}, \dots, m_r$ into the sequence of trees $m_r^*, \dots, m_{s+1}^*, m_s^*, m_{s+1}^*, \dots, m_1^*$. If m is symmetric, then $m = m^*$, and there exists an integer $0 \leq i < r$ such that the sequence $m_1, \dots, m_{s-1}, m_s, m_{s+1}, \dots, m_r$ coincides (term by term, in lexicographical order) with the sequence $m_{r+i}^*, \dots, m_{s+1+i}^*, m_s^*, m_{s+1+i}^*, \dots, m_{1+i}^*$ (indices are taken in the set $\{1, 2, \dots, r\}$ modulo r). If the value of i is equal to 0, we say that l_s is a *geometric axis of symmetry* of m . In particular, if l_s is an axis of symmetry, $m_{s-k}^* = m_{s+k}$ for each choice of k .

The first non-trivial observation is the following lemma, which uses critically that the number of sons of the root is an odd number.

Lemma 14. *Let $m \in \mathcal{S}_{\blacksquare}$. Then m has a geometric axis of symmetry.*

Proof. Consider the reflection π_1 , which transforms m into m^* . Because of $m = m^*$, there exists a value $0 \leq i < r$ such that the sequence of trees $m_1 m_2 \dots m_r$ is equal to the sequence $m_{r+i}^* m_{r-1+i}^* \dots m_{1+i}^*$. For each choice of i , the equation $r + i + 1 - k \equiv k \pmod{r}$ has solution $k \equiv 2^{-1}(1 + i) \pmod{r}$ (r is an odd number). This shows that for every i there exist two trees such that $m_k^* = m_{r+i-k}^* = m_k$, and l_k is a geometric axis of symmetry, as we wanted to prove. \square

Without loss of generality, we can suppose that l_1 is a geometric axis of symmetry of elements in \mathcal{S}_\blacksquare . The following proposition provides a close relation between different geometric axes of symmetry of a given tree in \mathcal{S}_\blacksquare .

Proposition 15. *Let $m \in \mathcal{S}_\blacksquare$. Let l_1 and l_s be different geometric axes of symmetry of m . Then $m_1 = m_s$.*

Proof. Let us suppose that the degree of the root is r (recall that r is an odd integer). To prove the proposition we use that the composition of two symmetries in the plane coincides with a rotation. More concretely, the rotation $\pi_s \circ \pi_1$ sends the geometric son with label 1 to the geometric son with label $1 + 2(s - 1) = 2s - 1$ (reducing conveniently modulo r). We say that the rotation $\pi_s \circ \pi_1$ is of angle $2s$. In a similar way, the rotation $\pi_1 \circ \pi_s$ sends 1 to $1 - 2s$ (this rotation is of angle $-2s$).

Apply the rotation $\pi_s \circ \pi_1$ n times. This rotation sends the geometric son 1 to $1 + 2(s - 1)n$, and leaves the tree fixed (because both π_1 and π_s leave the tree fixed). Denote by x the value in $\{1, 2, \dots, r - 1\}$ such that $x \equiv 2^{-1}(r)$ (it exists because r is an odd number). Then, taking $n = x$, the geometric son 1 is sent to the geometric son $1 + 2(s - 1)n \equiv 1 + (s - 1)r = s$. Consequently, $m_1 = m_s$, as we wanted to prove. \square

In Proposition 15 we have shown that all subtrees corresponding to geometric axis of symmetry are equal, and that one can be reached from another by a convenient rotation. Consequently, if l_1 and l_s are geometric axis of symmetry, and there is no $1 < n < s$ such that l_n is an axis of symmetry, then $l_{1+(s-1)k}$ is also a geometric axis of symmetry for each value of k . If there are n geometric axis of symmetry, then the total number of geometric sons is $n + n(s - 2)$, where $n(s - 2)$ counts the number of geometric sons which are not associated to geometric axis of symmetry. Hence, $n(s - 1) = r$, and n and $s - 1$ are odd integers.

As a summary of the previous discussion, we have shown that every element in \mathcal{S}_\blacksquare can be codified in the form $sm_1m_2 \dots m_{k-1}m_k m_k^* m_{k-1}^* \dots m_2^* m_1^* sm_1 \dots$, where s is a symmetric mobile. In other words, in the previous sequence the word $sm_1m_2 \dots m_{k-1}m_k m_k^* m_{k-1}^* \dots m_2^* m_1^*$ is repeated an odd number of times, and s is a symmetric mobile. To get the counting formula, let us define the family of *primitive words* in the following way: we take as an alphabet the elements in \mathcal{B} (recall Expression (6)). A primitive word W_1 over this alphabet is an ordered sequence of elements in \mathcal{B} , with odd length greater or equal than three, $W_1 = sm_1m_2 \dots m_r m_{r+1} \dots m_{2r}$, such that s is symmetric, $m_{r+i} = m_{r-i}^*$, and there is not a shorter primitive word W_2 such that the concatenation of W_2 gives W_1 . For instance, if s, m_1, m_2 are pairwise different and s is symmetric, then $sm_1m_1^*$ is a primitive word, but observe that the word $sm_1m_2m_2^*m_1^*sm_1m_2m_2^*m_1^*sm_1m_2m_2^*m_1^*$ is not, because the second word it is the concatenation of $sm_1m_2m_2^*m_1^*$. It is clear that a general word (starting with a symmetric letter s) decomposes into primitive words. The number of such repetitions is the *number of components* of the word (for instance, $sm_1m_2m_2^*m_1^*sm_1m_2m_2^*m_1^*sm_1m_2m_2^*m_1^*$ has three components).

Let $\mathbf{P}(z, u)$ be the GF associated to the set of primitive words. In order to find an expression for $\mathbf{P}(z, u)$, we need to recall the definition of the *classical Möbius function* $\mu(n)$: let n be a non-negative integer which is not square-free. Then $\mu(n) = 0$. If n is square-free ($n = p_1p_2 \dots p_r$, where p_1, p_2, \dots, p_r are pairwise different prime numbers), $\mu(n) = (-1)^r$ (r counts the number of primes in the decomposition of n). Finally, by convention, $\mu(1) = -1$. The next proposition shows the expression for $\mathbf{P}(z, u)$.

Proposition 16. *The GF associated to primitive words is*

$$\mathbf{P}(z, u) = \sum_{k=0}^{\infty} \mu(1 + 2k) u^k (z^{2+4k} + \vec{\mathbf{S}}_{\Delta}(z^{1+2k}, u^{1+2k})) \frac{\mathbf{B}(z^{2+4k}, u^{2+4k}) u^{1+2k}}{1 - \mathbf{B}(z^{2+4k}, u^{2+4k}) u^{1+2k}},$$

where μ is the classical Möbius function, z marks danglings and u marks the level of obstruction.

Proof. In order to get an expression for $\mathbf{P}(z, u)$, we use an inclusion–exclusion argument. All the time, we suppose that the first letter of words is a symmetric one. The GF associated to words whose first letter is symmetric and with at least one component is

$$\mathbf{SP}(z, u) = (z^2 + \vec{\mathbf{S}}_{\Delta}(z, u)) \frac{\mathbf{B}(z^2, u^2) u}{1 - \mathbf{B}(z^2, u^2) u}.$$

(The term u in the fraction is used to codify correctly the level of obstruction). This GF is not $\mathbf{P}(z, u)$, because here we are considering words with an arbitrary number of components. The first step consists in erasing from $\mathbf{SP}(z, u)$ the words whose number of components is of the form p^m , where p is a prime number. This GF can be written in the form

$$\mathbf{SP}(z, u) - \sum_{p \text{ prime}} \mathbf{SP}(z^p, u^p).$$

The previous sum counts exactly words with 1 component. Words with a number p^m of components are not counted here, because they appear once on every summand of the equation. Consequently, the previous GF counts exactly primitive words, and there is an extra error term that must be erased.

Now we consider pairs of primes p, q , and erase words with $p^a q^b$ components twice. Hence, we must sum $\mathbf{SP}(z^{pq}, u^{pq})$ to get the exact sum and we consider the GF

$$\mathbf{SP}(z, u) - \sum_{p \text{ prime}} \mathbf{SP}(z^p, u^p) + \sum_{p < q \text{ primes}} \mathbf{SP}(z^{pq}, u^{pq}).$$

This GF is associated to words with either 1 component or n components, such that n is neither a power of a prime nor a number of the form $p^a q^b$. The rest of the values of n must be corrected in a similar way. This argument can be generalized easily using the following fact: for $n = p_1^{\alpha_1} p_2^{\alpha_2} \dots p_r^{\alpha_r}$, the sum

$$1 - \binom{r}{1} + \binom{r}{2} - \dots + (-1)^r \binom{r}{r}$$

is equal to 0. This fact is translated into GFs, getting the sum

$$\sum_{k=0}^{\infty} \mu(1 + 2k) \mathbf{SP}(z^{1+2k}, u^{1+2k}),$$

which counts only the primitive words (i.e. words with one component). \square

Remark 1. The previous proposition can be proved using Möbius inversion arguments, but we prefer to exhibit this proof because it shows, in some sense, the structural behavior of the problem.

Once we know the GF for primitive words, the expression for the GF of symmetric \blacksquare -rooted trees is easy:

$$\mathbf{S}_{\blacksquare}(z, u) = \sum_{k=0}^{\infty} u^k \mathbf{P}(z^{1+2k}, u^{1+2k}). \tag{11}$$

The term u^k that appears in the previous expression is needed in order to get the correct level of obstruction (it corresponds to the contribution of the root vertex). As a conclusion of this section, we have proved the following theorem.

Theorem 17. Let $W(z, u)$ be the unique function defined by the implicit equation

$$\mathbf{W}(z, u) = \frac{(z^2 - z + z/(1 - \mathbf{W}(z, u)))^2 u}{1 - (z^2 - z + z/(1 - \mathbf{W}(z, u)))^2 u}, \tag{12}$$

with positive Taylor coefficients. Let $\mathbf{B}(z, u)$ and $\mathbf{P}(z, u)$ be the auxiliary functions

$$\begin{aligned} \mathbf{B}(z, u) &= z^2 + z/(1 - \mathbf{W}(z, u))^2 - z, \\ \mathbf{P}(z, u) &= \sum_{k=0}^{\infty} \mu(1 + 2k) u^k \left(z^{2+4k} + \frac{z^{1+2k} \mathbf{W}(z^{2+4k}, u^{2+4k})}{1 - \mathbf{W}(z^{2+4k}, u^{2+4k})} \right) \frac{\mathbf{B}(z^{2+4k}, u^{2+4k}) u^{1+2k}}{1 - \mathbf{B}(z^{2+4k}, u^{2+4k}) u^{1+2k}}. \end{aligned}$$

With this notation, the GF associated to \mathcal{C} is

$$\begin{aligned} \mathbf{T}(z, u) &= \frac{1}{2}z \frac{\mathbf{W}(z, u)^2}{1 - \mathbf{W}(z, u)} + \frac{1}{2}z \left(1 + \frac{\mathbf{B}(z^2, u^2)u}{1 - \mathbf{B}(z^2, u^2)u} \right) \frac{\mathbf{W}(z^2, u^2)}{1 - \mathbf{W}(z^2, u^2)} \\ &+ \frac{1}{4\sqrt{u}} \sum_{d=0}^{\infty} \frac{\varphi(1+2d)}{1+2d} \log \left(\frac{1 + u\sqrt{u}\mathbf{B}(z^{1+2d}, u^{1+2d})}{1 - u\sqrt{u}\mathbf{B}(z^{1+2d}, u^{1+2d})} \right) - \frac{1}{2}\mathbf{B}(z, u) \\ &+ \frac{1}{2} \sum_{d=0}^{\infty} u^d \mathbf{P}(z^{1+2d}, u^{1+2d}) - \frac{1}{2}\mathbf{W}(z, u)(\mathbf{B}(z, u) - z^2) \\ &- \frac{1}{2} \frac{\mathbf{B}(z^2, u^2)u}{1 - \mathbf{B}(z^2, u^2)u} \frac{z\mathbf{W}(z^2, u^2)}{1 - \mathbf{W}(z^2, u^2)} \end{aligned} \tag{13}$$

where z marks danglings and u marks the level of obstruction.

Proof. Function $\mathbf{W}(z, u)$ is the one defined implicitly by Eq. (7). The expression for $\mathbf{P}(z, u)$ is deduced in Proposition 16. In order to get the result, we add the expressions (with the corresponding sign) obtained in Eqs. (8)–(11)), writing them in terms of $\mathbf{W}(z, u)$, $\mathbf{B}(z, u)$ and $\mathbf{P}(z, u)$. \square

The first terms in the expansion of $\mathbf{T}(z, u)$ can be computed using a symbolic manipulator (we use Maple), truncating the infinite sums that appear in the previous expressions. We obtain the following ones:

$$\begin{aligned} \mathbf{T}(z, u) &= z^6u + (z^9 + z^{10})u^2 + (3z^{12} + 2z^{13} + z^{14})u^3 \\ &+ (12z^{15} + 16z^{16} + 5z^{17} + z^{18})u^4 + (52z^{18} + 117z^{19} + 68z^{20} + 9z^{21} + z^{22})u^5 \\ &+ (274z^{21} + 890z^{22} + 820z^{23} + 236z^{24} + 19z^{25} + z^{26})u^6 \\ &+ (1548z^{24} + 6654z^{25} + 8836z^{26} + 4317z^{27} + 750z^{28} + 35z^{29} + z^{30})u^7 + \dots \end{aligned}$$

Once we have obtained the enumeration for the class \mathcal{C} , the GF associated to \mathcal{Y} is a straightforward calculation.

Theorem 18. The GF associated to the set $\bigcup_{k=1}^{\infty} \mathcal{Y}_k$ is

$$\mathbf{Y}(z, u) = \frac{1}{u} \exp \left(\sum_{m=1}^{\infty} \frac{u^m}{m} (\mathbf{T}(z^m, u^m) + z^{3m}) \right) - \frac{1}{u} \tag{14}$$

where z marks vertices, u marks the level of obstruction and \mathbf{T} is defined in Theorem 17. In particular, $|\mathcal{Y}_k| = [u^k]\mathbf{Y}(1, u)$.

Proof. Every map in $\mathcal{Y} = \bigcup_{k=1}^{\infty} \mathcal{Y}_k$ is a proper multiset of elements of $\mathcal{C} \cup \{K_3\}$. Consequently, $\mathcal{Y} = \text{Mul}_{>0}$ and Eq. (14) is satisfied (we just need to introduce extra variables u in order to get the correct level of obstruction). \square

As we have done for the connected case, the first terms for $\mathbf{Y}(z, u)$ are

$$\begin{aligned} \mathbf{Y}(z, u) &= z^3 + 2z^6u + (3z^9 + z^{10})u^2 + (7z^{12} + 3z^{13} + z^{14})u^3 \\ &+ (20z^{15} + 20z^{16} + 6z^{17} + z^{18})u^4 + (77z^{18} + 140z^{19} + 76z^{20} + 10z^{21} + z^{22})u^5 \\ &+ (367z^{21} + 1052z^{22} + 904z^{23} + 248z^{24} + 20z^{25} + z^{26})u^6 + \dots \end{aligned}$$

4.2.3. Asymptotic enumeration

The singularity analysis of the function $\mathbf{T}(u) = \mathbf{T}(1, u)$ is related to the singular nature of the function $\mathbf{W}(u) = \mathbf{W}(1, u)$ defined in Theorem 17. The main observation is that $\mathbf{W}(u)$ is defined implicitly via an equation of the form $\Phi(u, \mathbf{W}(u)) = 0$. Hence, the Implicit Function Theorem asserts that $\mathbf{W}(u)$ can be expressed in terms of u in all points such that $\Phi_w(u, w) \neq 0$. This principle is applied here using a result of Meir and Moon [8] (which appears as Theorem VII.3 of [6]). We rephrase here, for convenience, a reduced version.

Theorem 19. Let $y(u) = \sum_{k \geq 0} y_k u^k$ be an analytic function at the origin, with $y_0 = 0$ and $y_k \geq 0$. Suppose that $y(u)$ can be written in the form $y(u) = \mathbf{G}(u, y(u))$, where $\mathbf{G}(u, w)$ verifies the following conditions:

1. $\mathbf{G}(u, w) = \sum_{m,n \geq 0} g_{m,n} u^m w^n$ is analytic in the complex region $\{(u, w) \in \mathbb{C}^2 : |u| < R, |w| < S\}$, for some positive values R, S .
2. $g_{m,n} \geq 0$, $g_{0,0} = 0$ and $g_{0,1} \neq 1$.
3. $g_{m,n} > 0$ for some m and some $n \geq 2$.
4. There exists $0 < \rho < R$ and $0 < \tau < S$ satisfying the system of equations $\mathbf{G}(\rho, \tau) = \tau$, $\mathbf{G}_w(\rho, \tau) = 1$ (also called characteristic system).

Under these hypotheses, $y(u)$ converges at $u = \rho$, where it has a square-root type singularity,

$$y(u) = \tau + a_1(1 - u/\rho)^{1/2} + O((1 - u/\rho)).$$

If the sequence $\{y_k\}_{k \geq 0}$ is not periodic, then ρ is the unique dominant singularity of $y(u)$ in the disk $\{u \in \mathbb{C} : |u| \leq \rho\}$, and $\{y_k\}_{k \geq 0}$ satisfies the following growth behavior

$$y_k = -\frac{a_1}{2\sqrt{\pi}} k^{-3/2} \rho^{-k} (1 + O(k^{-1})).$$

In our problem the function $\mathbf{G}(u, w)$ is

$$\mathbf{G}(u, w) = \frac{u}{(1-w)^4} \frac{1}{1 - \frac{u}{(1-w)^4}},$$

which is deduced by manipulating Eq. (12). Verification of conditions 1, 2 and 3 of this theorem are a straightforward computation. However, it is not immediate to find solutions of the characteristic system. Observe that the system of equations $\mathbf{G}(\rho, \tau) = \tau$, $\mathbf{G}_w(\rho, \tau) = 1$ can be written in the form $P_1(\rho, \tau) = 0$, $P_2(\rho, \tau) = 0$, where P_1 and P_2 are polynomials in 2 variables, with expressions

$$\begin{aligned} P_1(u, w) &= u + uw + 4w^2 - 6w^3 + 4w^4 - w^5 - w = 0, \\ P_2(u, w) &= u + 8w - 18w^2 + 16w^3 - 5w^4 - 1 = 0. \end{aligned} \tag{15}$$

Elimination theory let us obtain the set of the common solutions for a system of polynomial equations. Using the algebraic programme Maple and the function Resultant over the characteristic system (15) we get the polynomials (up to a constant factor)

$$\begin{aligned} R(u) &= u^3(256u^2 - 29701u + 2048), \\ r(w) &= (w - 1)^3(4w^2 + 5w - 1). \end{aligned}$$

The smallest positive root of R is $\rho = 1/512(29701 - 4633\sqrt{41}) \doteq 0.06899494$, and the corresponding value of w is $\tau = 1/8(-5 + \sqrt{41}) \doteq 0.17539053$. In other words, the point $(\rho, \tau) \doteq (0.06899494, 0.17539053)$ is a solution of the characteristic equation, and ρ is the smallest possible positive value for u . We have proved the following lemma.

Lemma 20. The smallest (and unique with this minimal modulo) singularity of $\mathbf{W}(u)$ is $\rho = 1/512(29701 - 4633\sqrt{41}) \doteq 0.06899494$. Around $u = \rho$, $\mathbf{W}(u)$ admits a singular expansion of the form

$$\mathbf{W}(u) = \tau + a_1(1 - u/\rho)^{1/2} + O((1 - u/\rho)),$$

where $\tau = 1/8(-5 + \sqrt{41}) \doteq 0.17539053$.

From now on we write $(1 - u/\rho)^{1/2} = U$. Consequently $\rho(1 - U^2) = u$. Computation of the singular expansion of $\mathbf{T}(u)$ needs the singular expansion of $\mathbf{W}(u)$ up to higher terms (concretely, up to order 3). Write $\mathbf{W}(u) = \tau + a_1U + a_2U^2 + a_3U^3 + O(U^4)$, where a_r depends only on the evaluation of the derivatives of $\mathbf{G}(u, w)$ at (ρ, τ) . Using the relation $\mathbf{G}(u, \mathbf{W}(u)) = \mathbf{G}(\rho(1 - U^2), \mathbf{W}(U)) = \mathbf{W}(U)$ we obtain directly its Taylor coefficients in terms of the a_i 's by the indeterminate coefficients method: writing $\mathbf{G}(\rho(1 - U^2), \mathbf{W}(U)) - \mathbf{W}(U) = A_0 + A_1U + A_2U^2 + \dots$, it is clear then that $A_i = 0$ for

all i , and each A_i can be expressed only in terms of the different a_i 's. Using this argument we get $a_1 \doteq -0.23042912$, $a_2 \doteq 0.08345086$ and $a_3 \doteq -0.04668570$ (exact expressions can be obtained, but they are involved).

We have all results we need to obtain the asymptotic behavior for the family \mathcal{T} . However, to make expressions simpler, we write Eq. (13) as $F(u) + G(u)$ (we have substituted z equal to 1), where G is analytic at $u = \rho$. This is stated in the following lemmas.

Lemma 21. *With the notation of Theorem 17 and writing $\mathbf{B}(1, u) = \mathbf{B}(u)$, each term in the sum*

$$\frac{1}{2} \left(1 + \frac{\mathbf{B}(u^2)u}{1 - \mathbf{B}(u^2)u} \right) \frac{\mathbf{W}(u^2)}{1 - \mathbf{W}(u^2)} - \frac{1}{2} \frac{\mathbf{B}(u^2)u}{1 - \mathbf{B}(u^2)u} \frac{\mathbf{W}(u^2)}{1 - \mathbf{W}(u^2)} = \frac{1}{2} \frac{\mathbf{W}(u^2)}{1 - \mathbf{W}(u^2)}$$

is analytic in the disk $\{u \in \mathbb{C} : |u| \leq \rho\}$.

Proof. Recall that $\mathbf{W}(u)$ ceases to be analytic at $z = \rho$, and that $\mathbf{W}(\rho) = \tau < 1$. Then, $\mathbf{W}(u)$ is analytic at $u = \rho^k$ for $k > 1$, and $\mathbf{W}(\rho^k) < 1$. Therefore, $\mathbf{W}(u^2)$ is smaller than 1 for $0 \leq u \leq \rho$. That is, the function $1 - \mathbf{W}(u^2)$ is not 0 in a neighborhood of $u = \rho$, and the corresponding inverse function $(1 - \mathbf{W}(u^2))^{-1}$ is an analytic function in the disk $\{u \in \mathbb{C} : |u| \leq \rho\}$. \square

In the following lemma we show that the involved term associated to $\mathbf{P}(z, u)$ is also analytic, and we do not need to consider it in the asymptotic analysis.

Lemma 22. *With the notation used in Theorem 17, and writing $\mathbf{B}(1, u) = \mathbf{B}(u)$, functions*

$$\mathbf{P}(u) = \mathbf{P}(1, u) = \sum_{k=0}^{\infty} \mu(1 + 2k)u^k \left(\frac{1}{1 - \mathbf{W}(u^{2+4k})} \right) \frac{\mathbf{B}(u^{2+4k})u^{1+2k}}{1 - \mathbf{B}(u^{2+4k})u^{1+2k}}, \sum_{d=0}^{\infty} u^d \mathbf{P}(u^{1+2d}),$$

are analytic in the disk $\{u \in \mathbb{C} : |u| \leq \rho\}$.

Proof. A singularity of $\mathbf{P}(u)$ smaller than ρ could appear because of either the cancelation of a term of the form $1 - \mathbf{W}(u^{2+4k})$, a cancelation of a term of the form $1 - \mathbf{B}(u^{2+4k})u^{1+2k}$ or the divergence of the sum which defines $\mathbf{P}(u)$. By the same argument used in the previous lemma, the first and the second sources do not exist. We only need to show that the sum is finite at $u = \rho$. Taking absolute values we get

$$\begin{aligned} |\mathbf{P}(u)| &< \sum_{k=0}^{\infty} |u|^{3k+1} \left| \frac{1}{1 - \mathbf{W}(u^{2+4k})} \right| \left| \frac{\mathbf{B}(u^{2+4k})}{1 - \mathbf{B}(u^{2+4k})} \right| \\ &< \frac{\rho}{1 - \rho^3} \frac{1}{(1 - \mathbf{W}(\rho^2))} \frac{\mathbf{B}(\rho^2)}{(1 - \mathbf{B}(\rho^2))} < \infty, \end{aligned}$$

so $\mathbf{P}(u)$ is analytic in the disk $\{u \in \mathbb{C} : |u| \leq \rho\}$. A similar bounding-type argument shows that the sum $\sum_{d=0}^{\infty} u^d \mathbf{P}(u^{1+2d})$ is also analytic in the domain $\{u \in \mathbb{C} : |u| \leq \rho\}$. \square

The previous lemmas can be interpreted from a combinatorial point of view: the number of symmetric maps is exponentially small compared with maps which are not symmetric. As a consequence, to obtain the asymptotic nature of the family we only need to deal with the following GF:

$$\begin{aligned} &\frac{1}{2} \frac{\mathbf{W}(u)^2}{1 - \mathbf{W}(u)} + \frac{1}{4\sqrt{u}} \sum_{d=0}^{\infty} \frac{\varphi(1 + 2d)}{1 + 2d} \log \left(\frac{1 + u\sqrt{u}\mathbf{B}(u^{1+2d})}{1 - u\sqrt{u}\mathbf{B}(u^{1+2d})} \right) \\ &- \frac{1}{2} \mathbf{B}(u) - \frac{1}{2} \mathbf{W}(u)(\mathbf{B}(u) - 1). \end{aligned} \tag{16}$$

In the next theorem we analyze the singular expansion of $\mathbf{T}(u)$ around $u = \rho$. We have shown that we can restrict ourselves to the study of the GF stated in Eq. (16).

Theorem 23. Let $\mathbf{T}(u)$ the GF defined in [Theorem 17](#). The smallest (and unique) singularity of $\mathbf{T}(u)$ is located at $\rho = 1/512(29701 - 4633\sqrt{41}) \doteq 0.06899494$. The singular expansion of $\mathbf{T}(u)$ around $u = \rho$ is of the form

$$\mathbf{T}(u) = T_0 + T_2U^2 + T_3U^3 + O(U^4) \tag{17}$$

where $U = (1 - u/\rho)^{1/2}$, $T_0 \doteq 0.04532809$ and $T_3 \doteq 0.05647932$.

Proof. As we have shown, we only need to study [Eq. \(16\)](#). The dominant singularity of the GF in [Eq. \(16\)](#) is either defined by the singularity of $\mathbf{W}(u)$ or the parameter of one of the logarithmic terms in the cyclic sum. We show that source of the singularity is $\mathbf{W}(u)$, and not the cancelation of a denominator in the logarithms. Function $\mathbf{B}(u)$ is an increasing function for $u \in \mathbb{R}$, and its unique singularity is located at $u = \rho$. Then, for $|u| \leq \rho$ we have that

$$|u\sqrt{u}\mathbf{B}(u)| < |\rho^{3/2}||\mathbf{B}(\rho)| = \frac{|\rho^{3/2}|}{|(1 - W(\rho))^2|} = \frac{\rho^{3/2}}{(1 - \tau)^2} \doteq 0.02665196 < 1.$$

Consequently, terms inside the logarithms do not vanish in the region $\{u \in \mathbb{C} : |u| \leq \rho\}$. The function $\frac{1}{2\sqrt{u}} \sum_{d=1}^{\infty} \frac{\varphi(1+2d)}{1+2d} \log\left(\frac{1+u\sqrt{u}\mathbf{B}(u^{1+2d})}{1-u\sqrt{u}\mathbf{B}(u^{1+2d})}\right)$ is analytic at $u = \rho$, so we only need to study

$$\frac{1}{2} \frac{\mathbf{W}(u)^2}{1 - \mathbf{W}(u)} + \frac{1}{4\sqrt{u}} \log\left(\frac{1 + u\sqrt{u}\mathbf{B}(u)}{1 - u\sqrt{u}\mathbf{B}(u)}\right) - \frac{1}{2}\mathbf{B}(u) - \frac{1}{2}\mathbf{W}(u)(\mathbf{B}(u) - 1). \tag{18}$$

We work as in [Lemma 20](#): we develop $\mathbf{W}(u)$ in terms of its singular expansion around $u = \rho$, $\mathbf{W}(u) = \tau + a_1U + a_2U^2 + a_3U^3 + \dots$ and we substitute this development in [Expression \(18\)](#). We obtain a development of the form $\mathbf{T}(U) = T_0 + T_1U + T_2U^2 + T_3U^3 + \dots$, where T_0, \dots, T_3 are functions of τ, a_1, a_2 and a_3 . It is important to notice that the expression of T_1 vanishes *identically*. This is an usual phenomena that appear when the dissymmetry theorem is applied. The explicit expression for T_3 is involved and can be computed easily using a computer program, and the values obtained in [Lemma 20](#). The value of T_0 corresponds with the evaluation of \mathbf{T} on $u = \rho$. This calculation can be done using Maple and using the whole expression in [Theorem 17](#). In fact, in this computation we separate singular terms (from which we know the singular expansion) from the analytic terms (which can be evaluated with the desired precision). \square

As a consequence of the previous computations in the following corollary we get the asymptotic enumeration.

Corollary 24. The number $[u^k]\mathbf{T}(u) = |\mathcal{C}_k|$ verifies

$$|\mathcal{C}_k| = C \cdot k^{-5/2} \cdot \rho^{-k}(1 + O(k^{-1})),$$

where $\rho = 1/512(29701 - 4633\sqrt{41}) \doteq 0.06899494$ (and $\rho^{-1} \doteq 14.49381704$) and $C \doteq 0.02389878$.

Proof. Application of the Transfer Theorem ([Eq. \(2\)](#)) on [Expression \(17\)](#). Notice that $C = \frac{T_3}{\Gamma(-3/2)} = \frac{3T_3}{4\sqrt{\pi}}$. \square

To conclude, we make a similar analysis to obtain the asymptotic behavior for $|\mathcal{Y}_k|$.

Corollary 25. The number $[u^k]\mathbf{Y}(u) = |\mathcal{Y}_k|$ verifies

$$|\mathcal{Y}_k| = C' \cdot k^{-5/2} \cdot \rho^{-k}(1 + O(k^{-1})),$$

where $\rho = 1/512(29701 - 4633\sqrt{41}) \doteq 0.06899494$ (and $\rho^{-1} \doteq 14.49381704$) and $C' \doteq 0.02575057$.

Proof. Writing $z = 1$ in Eq. (14) we get the expression $\mathbf{Y}(u) = \frac{1}{u} \exp(\sum_{i=1}^{\infty} \frac{u^m}{m} (\mathbf{T}(u^m) + 1)) - \frac{1}{u}$, which can be written as

$$\exp(u\mathbf{T}(u)) \frac{1}{u} \exp\left(\sum_{m=2}^{\infty} \frac{u^m}{m} \mathbf{T}(u^m)\right) \exp\left(\sum_{m=1}^{\infty} \frac{u^m}{m}\right) - \frac{1}{u}.$$

We show that the term $\exp(\sum_{m=2}^{\infty} \frac{u^m}{m} \mathbf{T}(u^m)) \exp(\sum_{m=1}^{\infty} \frac{u^m}{m})$ is analytic at $u = \rho$. The term $\exp(\sum_{m=1}^{\infty} \frac{u^m}{m})$ is equal to $(1 - u)^{-1}$, which is analytic at $u = \rho$. The term $\exp(\sum_{m=2}^{\infty} \frac{u^m}{m} \mathbf{T}(u^m))$ is analyzed in the following way: observe that each term in the sum is analytic at $u = \rho$. The sum is finite at $u = \rho$ because

$$\sum_{m=2}^{\infty} \frac{u^m}{m} \mathbf{T}(\rho^m) < \rho \sum_{m=1}^{\infty} \frac{1}{m} \mathbf{T}(\rho^m) = -\rho \sum_{k=0}^{\infty} t_k \log(1 - \rho^k).$$

Now we use that if $0 \leq x < 1$, then $-\log(1 - x) \leq x$. Consequently, $-\sum_{k=0}^{\infty} t_k \log(1 - \rho^k) < \sum_{k=0}^{\infty} t_k \rho^k = T_0 < \infty$. Hence, the initial sum is analytic in the disk $\{u \in \mathbb{C} : |u| \leq \rho\}$.

In a neighborhood of $u = \rho$, the previous function can be written in the following way:

$$\mathbf{Y}(u) = \exp(\rho(1 - U^2)(T_0 + T_2U^2 + T_3U^3 + O(U^4))) \frac{1}{u} \exp\left(\sum_{m=2}^{\infty} \frac{u^m}{m} \mathbf{T}(u^m)\right) \frac{1}{1 - u} - \frac{1}{u}.$$

Developing the first exponential in terms of U , and applying another Time Transfer Theorem gives the result as it is stated. Notice that we need to truncate the infinite sum $\sum_{m=2}^{\infty} \frac{u^m}{m} \mathbf{T}(u^m)$ in order to get an approximation for C' . \square

5. Conclusions

In this paper we determined all outerplanar obstructions for graphs of feedback vertex set bounded by k , for each $k \geq 1$. Our proofs were based on a suitable mechanism (the operation Δ) able to construct obstructions from simple ones. This mechanism can also be used to construct more, non-outerplanar, obstructions. This could imply lower bounds for the size of $\mathbf{obs}(\mathcal{F}_k)$ of the form c^k where $c > 14.49381704$. We conclude this paper with some conjectures on \mathcal{F}_k .

A *face cover* of a plane graph G is a set of faces that are incident to all vertices of G . We denote by \mathcal{R}_k the set of all graphs with a planar embedding that has a face cover of size at most k . The set $\mathbf{obs}(\mathcal{R}_k)$ has been studied in [2]. It is not hard to see that graph duality establishes a bijection between \mathcal{C}_k and $\mathbf{obs}(\mathcal{R}_k) \cap \mathcal{L}$ where \mathcal{L} is the class of all duals of outerplanar graphs. This translates the lower bound of Corollary 25 to a lower bound for $\mathbf{obs}(\mathcal{R}_k)$.

We conclude with some conjectures around the set $\mathbf{obs}(\mathcal{F}_k)$.

Conjecture. *The following statements hold:*

1. Every graph in $\mathbf{obs}(\mathcal{F}_k)$ has $O(k^2)$ vertices.
2. \mathcal{Y}_k is the set of all K_4 -minor free graphs in $\mathbf{obs}(\mathcal{F}_k)$.
3. $|\mathbf{obs}(\mathcal{F}_k)| > c^{k \cdot \log k}$ for some $c > 1$.

Acknowledgments

The first author was supported by the Spanish “Ministerio de Ciencia e Innovación” project MTM2005-08618-C02-01 and by the European Research Council under the European Community’s 7th Framework Programme, ERC grant agreement no. 208471 - ExploreMaps project. The second author was supported by a scholarship from Alexander Onassis Public Benefit Foundation. The third author was supported by the project “Kapodistrias” (A/I 02839/28.07.2008) of the National and Kapodistrian University of Athens (project code: 70/4/8757).

References

- [1] F. Bergeron, G. Labelle, P. Leroux, *Combinatorial Species and Tree-Like Structures*, Cambridge University Press, 1997.
- [2] D. Bienstock, N. Dean, On obstructions to small face covers in planar graphs, *J. Combin. Theory Ser. B* 55 (2) (1992) 163–189.
- [3] M.J. Dinneen, Too many minor order obstructions (for parameterized lower ideals), in: *Proceedings of the First Japan–New Zealand Workshop on Logic in Computer Science*, Auckland, 1997, 3(11) 1997, pp. 1199–1206 (electronic).
- [4] M.J. Dinneen, K. Cattell, M.R. Fellows, Forbidden minors to graphs with small feedback sets, *Discrete Math.* 230 (1–3) (2001) 215–252. Paul Catlin memorial collection (Kalamazoo, MI, 1996).
- [5] P. Flajolet, A. Odlyzko, Singularity analysis of generating functions, *SIAM J. Discrete Math.* 3 (1990) 216–240.
- [6] P. Flajolet, R. Sedgewick, *Analytic Combinatorics*, Cambridge Univ. Press, 2008.
- [7] A.C. Giannopoulou, D.M. Thilikos, Obstructions for tree-depth, in: *EuroComb 2009: European Conference on Combinatorics, Graph Theory and Applications. 2009. Electronic Notes in Discrete Mathematics*, vol. 34, 2009, pp. 249–253.
- [8] A. Meir, J. Moon, On an asymptotic method in enumeration, *J. Combin. Theory, Ser. A* 51 (1) (1989) 77–89.
- [9] T.D. Parsons, The search number of a connected graph, in: *Proceedings of the Ninth Southeastern Conference on Combinatorics Graph Theory, and Computing Florida Atlantic Univ., Boca Raton, Fla., 1978*, in: *Congress. Numer.*, vol. XXI, Winnipeg, Man. Utilitas Math., 1978, pp. 549–554.
- [10] N. Robertson, P.D. Seymour, Graph minors. XX. Wagner’s conjecture, *J. Combin. Theory Ser. B* 92 (2) (2004) 325–357.
- [11] J. Rué, K.S. Stavropoulos, D.M. Thilikos, Outerplanar obstructions for feedback vertex set, in: *EuroComb 2009: European Conference on Combinatorics, Graph Theory and Applications. 2009. Electronic Notes in Discrete Mathematics*, vol. 34, 2009, pp. 167–171.
- [12] A. Takahashi, S. Ueno, Y. Kajitani, Minimal acyclic forbidden minors for the family of graphs with bounded path-width, *Discrete Math.* 127 (1–3) (1994) 293–304.
- [13] D.M. Thilikos, Algorithms and obstructions for linear-width and related search parameters, *Discrete Appl. Math.* 105 (2000) 239–271.