

# Analysis of the biological cycle of *Acartia clausi* (Copepoda) in a meso-oligotrophic coastal area of the eastern Mediterranean Sea using time-series analysis

E. D. Christou<sup>1</sup>, G. C. Verriopoulos<sup>2</sup>

<sup>1</sup> National Centre for Marine Research, Agios Kosmas, Hellinikon, GR-166 04 Athens, Greece

<sup>2</sup> Zoological Laboratory, University of Athens, Panepistimiopolis, GR-157 84 Athens, Greece

Received: 19 June 1992 / Accepted: 26 November 1992

**Abstract.** We evaluated the duration of Copepodite Stages C1 to C6, the biological cycle and the number of annual generations of the planktonic copepod *Acartia clausi* in a meso-oligotrophic area of the eastern Mediterranean Sea (Saronikos Gulf, Greece). The results were based on 95 zooplankton samples collected during the period November 1988 through June 1990, at intervals of 1, 2, 7 and 15 d, the sampling intervals being dependent on the abundance of *A. clausi*. Time-series analysis (cross-correlation) of fluctuations in the comparative abundance (percentages) of the copepodite stages present was used to determine the duration of the development stages and generation length. This methodology could significantly contribute to the identification of cohorts, and hence to the estimation of stage duration, from field data for a given copepod species. The development of *A. clausi* stages was not isochronal; duration of the first copepodite stage was shorter than that of the last three stages. The mean generation length estimated (28.6 d) is among the highest recorded in the literature for *A. clausi* at the range of temperatures prevailing in the area (13 to 25 °C). Throughout the year there were four or five generations. The possible limiting role of food availability on the duration of each stage and hence on generation length is also discussed.

## Introduction

In order to evaluate secondary production in the sea, it is necessary to collect data on the developmental stages of copepods, the duration of the biological cycle and the number of annual generations (Gaudy 1970, Edmondson and Winberg 1971, Bougis 1976, Tranter 1976, Greze 1978, Landry 1978, Uye 1982). Such studies are lacking for copepods of the eastern Mediterranean Sea.

Durations of Copepodite Stages C1 to C6 are usually estimated from laboratory observations in a controlled environment with an excess of food (Corkett 1968, Iwasaki et al. 1977, Uye 1980, Thompson 1982, Landry 1983). However, growth rates for any given species in the

field are often slower than those observed for the same species in the laboratory (Burkill and Kendall 1982).

In the present study, the development period of the copepodite stages and the generation length of the planktonic copepod *Acartia clausi* were estimated using cross-correlation analysis of its comparative abundance in the field. *A. clausi* is commonly found in enclosed bays and coastal areas where it often constitutes one of the most abundant copepod species (Specchi et al. 1981, Uye 1982, Ianora et al. 1985, Kimmerer and McKinnon 1985, Sullivan and McManus 1986, Christou 1990).

Similar studies have estimated stage duration from abundance peaks progressing through consecutive development stages (Gaudy 1976, 1984, McLaren 1978, Herman et al. 1984), whereby the development period of each stage is estimated as the interval between two successive peaks of two consecutive stages. In most cases, however, such estimates are difficult, if not impossible, because of cohort overlapping as a result of irregular fluctuations in abundance (Uye 1982, Uye et al. 1983, Gaudy 1984). The present study overcomes this difficulty by using cross-correlation analysis, which identifies statistically significant relationships between fluctuations in the abundance of any two development stages.

## Materials and methods

Samples were collected from a coastal station (about 12 m depth) in the eastern Saronikos Gulf (Aegean Sea, eastern Mediterranean), which is considered to be a meso-oligotrophic region (Friligos 1982, 1984, Ignatiades et al. 1982, 1983, Christou unpublished data). Samples were collected by oblique hauls at 1, 2, 7 and 15 d intervals during the period November 1988 through June 1990, the sampling intervals depending on the abundance of *Acartia clausi* in the zooplankton. A 132 µm net (Tranter and Smith 1968), equipped with a Hydrobios flowmeter, was used. The samples were preserved in buffered formalin (4%) according to Omori and Ikeda (1984).

Copepodite stages (C1, C2, C3, C4, C5♀, C5♂, C6♀ and C6♂) were identified and counted in 95 zooplankton samples. The duration of each copepodite stage was estimated from percentage abundance in order to minimize the effects of irregular and sharp fluctuations in density (individuals/m<sup>3</sup>).

**Table 1.** Time-series of sampling dates (constructed as indicated in "Materials and methods") used for cross-correlation analysis. Mean time (d) between two successive samplings (= sampling frequency) is shown in parentheses

1 (1.20 d)	2 (2.21 d)	3 (7.09 d)	4 (7.22 d)	5 (15.05 d)
7 May 90	18 Apr. 90	26 Mar. 90	20 Mar. 89	17 Nov. 88
8	20	3 Apr.	27	1 Dec.
9	23	9	3 Apr.	12
10	25	18	10	28
11	27	25	17	12 Jan. 89
13	30	2 May	24	30
14	2 May	9	2 May	20 Feb.
15	4	17	8	7 Mar.
17	7	25	15	20
18	9	30	22	3 Apr.
19	11	7 June	29	17
21	13	13	5 June	2 May
22	15		12	15
23	17		20	29
24	19		26	12 June
25	21		3 July	26
	23		10	10 July
	25		17	24
	28		24	10 Aug.
	30		31	22
			10 Aug.	6 Sep.
			16	23
			22	11 Oct.
			28	24
			6 Sep.	2 Nov.
			13	20
			23	4 Dec.
			2 Oct.	27
			11	9 Jan. 90
			18	22
			24	5 Feb.
			30	20
			6 Nov.	6 Mar.
			13	26
			20	9 Apr.
			27	23
			4 Dec.	9 May
			12	25
				13 June

Classification and non-metric multidimensional scaling (MDS; Sokal and Sneath 1963, Field et al. 1982, Clarke and Green 1988, Clarke and Warwick 1989) were employed to reveal (a) existing differences between stages, and (b) any possible similarities among the abundance fluctuations of the various stages. These multivariate techniques were applied to both transformed data (square-root) and percentages (Clarke and Warwick 1989) based on between-sample similarities, calculated according to Bray and Curtis (1957). This similarity measure is not affected by joint absences (Field and McFarlane 1968), and is therefore sufficiently robust for marine data (Field et al. 1982).

Statistically significant relationships between fluctuations in the abundance of any two stages were determined by cross-correlation analysis (Legendre and Legendre 1983). In order to apply cross-correlation analysis to the available data, we constructed a time-series which excluded certain samples, thus enabling the remaining samples to maintain a constant frequency for as long a period as possible (Table 1). Employing this method, we obtained time-series with frequencies of 1, 2, 7 and 15 d. Whenever the interval between two successive samples differed from the desired frequency, the next nearest sampling date was used. Based on the statistically significant

**Table 2.** *Acartia clausi*. Abundance (individuals/m<sup>3</sup>) of copepodite stages and adults in 1988–1990

Stage	$\bar{x}$	(%)	max.	(%)	(Date)
C1	78	(18.22)	1 461	(44.86)	(28 Mar. 1990)
C2	61	(14.30)	868	(29.27)	(10 Apr. 1989)
C3	64	(14.90)	1 316	(32.54)	(5 Apr. 1990)
C4	58	(13.48)	1 539	(28.31)	(24 Apr. 1989)
C5	47	(11.09)	858	(20.11)	(29 Mar. 1990)
(C5♀)	26	(6.10)	520	(9.56)	(24 Apr. 1989)
(C5♂)	21	(4.99)	380	(8.91)	(29 Mar. 1990)
C6	120	(28.00)	1 883	(44.09)	(29 Mar. 1990)
(C6♀)	81	(18.95)	1 254	(29.37)	(29 Mar. 1990)
(C6♂)	39	(9.06)	740	(44.30)	(30 May 1990)
Sum	428	(100)	5 437		(24 Apr. 1989)

time-lag estimated by cross-correlation between two time-series and using these time-series frequencies [i.e. (time-lag) × (frequency)], it was possible to estimate the time-interval between the appearance of any two stages. Based on these results, it was also possible to differentiate whether two stages were of the same or of successive generations. When the time-interval between two similar stages, but from different time-series, varied, the mean was taken for the total estimation. The duration of each stage (and hence the generation length) was estimated taking into account all statistically significant relationships between any two stages. The duration of each development stage and the generation length both represent the mean duration throughout the study period.

In general, males develop faster than females. A temporary increase in the proportion of males marks the beginning of a new generation (Gaudy 1984). In addition, fluctuations in the mature female:male ratio can be used as an indicator to delineate the different generations (Woodmanse 1958, Gaudy 1976, 1984). In the present study, the number of generations per year was estimated from the annual variations in the female:male ratio of adults (Gaudy 1984).

For the statistical analysis, the STATGRAPHICS (STSC 1989) and PRIMER (developed at Plymouth Marine Laboratory, Devon, England) programmes were used.

## Results

Fig. 1 shows the variations (total individuals/m<sup>3</sup>) and percentages of each copepodite stage of *Acartia clausi* in the zooplankton during November 1988 through June 1990 at 7 d time-intervals; Fig. 2 presents the same data for the end of March to the end of May 1990 at daily time-intervals. *A. clausi* was present in the zooplankton from January through early August 1989, after which month they almost disappeared for about 4 mo, reappearing in January 1990. The highest abundances were observed in late March, April and May. All copepodite stages and adults displayed similar patterns (Fig. 1) even over daily time-intervals (Fig. 2), which made the identification of cohorts impossible. Stage C1 (mean = 78 individuals/m<sup>3</sup>) and adult females (C6♀: mean = 81 individuals/m<sup>3</sup>) were present in greatest abundance, whereas the highest peaks (1539 and 1883 individuals/m<sup>3</sup>) were observed for Stage C4 and adults (C6), respectively (Table 2).

The classification and ordination techniques revealed similarities among the patterns of abundance of the various copepodite stages (Fig. 3). Both the dendrogram and

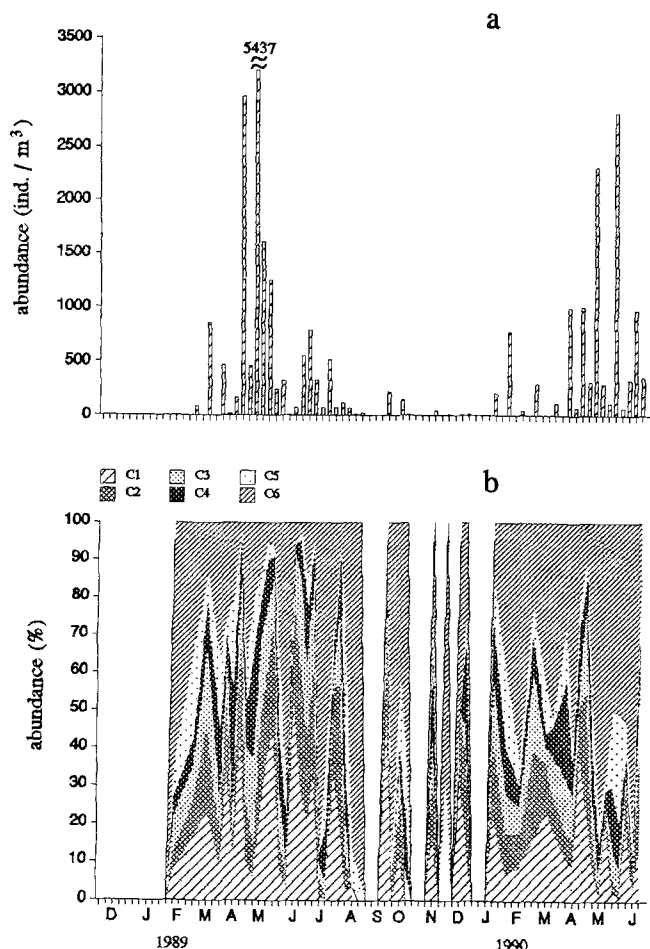

Fig. 1. *Acartia clausi*. Variations in total abundance (a) and percentage of population comprised by the different copepodite stages (b) during November 1988 through June 1990

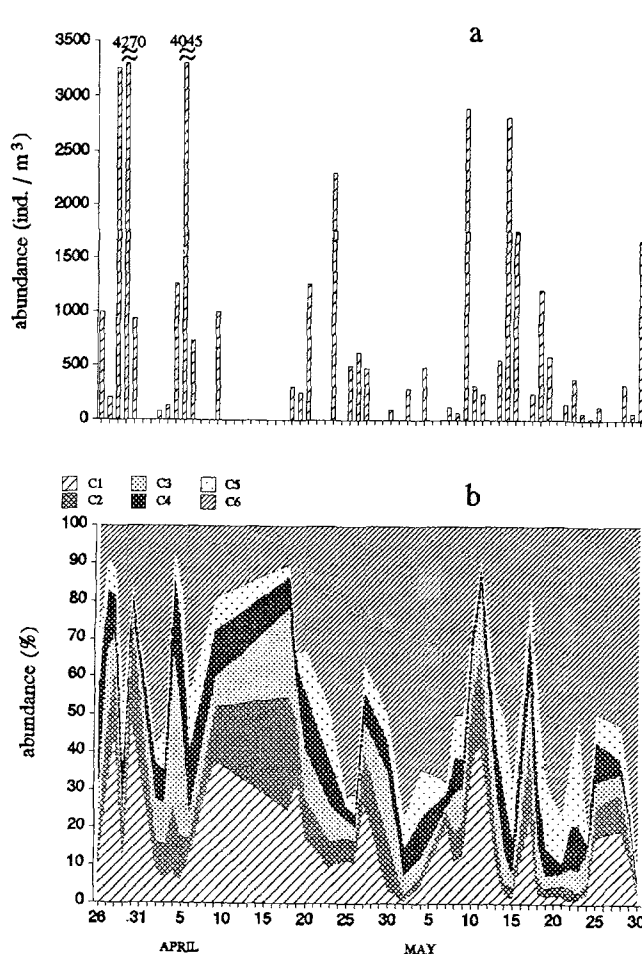

Fig. 2. *Acartia clausi*. Variations in total abundance (a) and percentage of population comprised by the different copepodite stages (b) from end of March to end of May 1990

MDS plots disclosed distinct similarities, especially between any two successive stages (Fig. 3). It is clear that the classification and MDS-mapping of stages, whether based on total abundance (Fig. 3a) or percentage (Fig. 3b), are almost identical. Both MDS plots in Fig. 3 are similar; the data points for C1 to C6 have circular configuration, reflecting the organism's biological cycle. The high similarity level (65%) of the dendrogram based on stage abundance (Fig. 3a) arises from the almost simultaneous fluctuations in abundance displayed by all stages (Fig. 3b).

By means of a time-series analysis, the similarities and the relationships between the abundance patterns of the various stages were qualitatively and quantitatively evaluated.

The time-series classification was based on frequencies of 1, 2, 7, and 15 d (Table 1). All possible combinations between any two stages were tested by means of cross-correlation analysis. Statistically significant ( $P < 0.05$ ) correlations between stages are shown in Figs. 4 and 5 and in Table 3. Significant correlations noted at Time-Lag 0 (data not shown) were mainly due to the almost identical patterns of abundance displayed by all stages. As indicated in "Materials and methods", the time-inter-

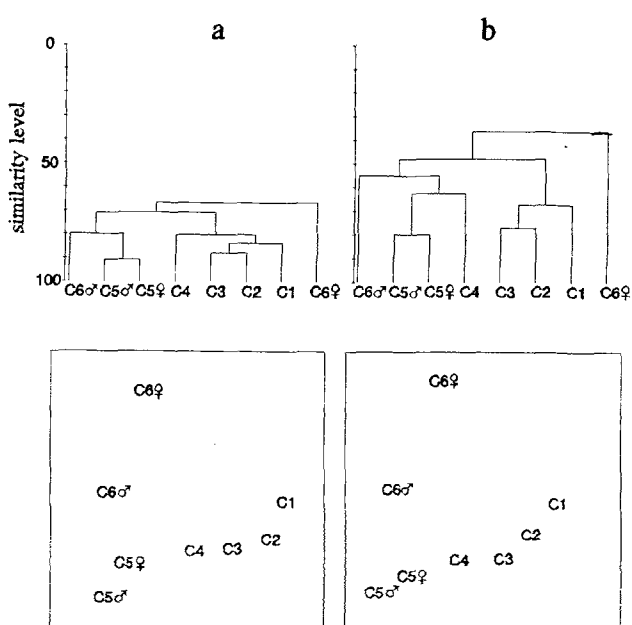
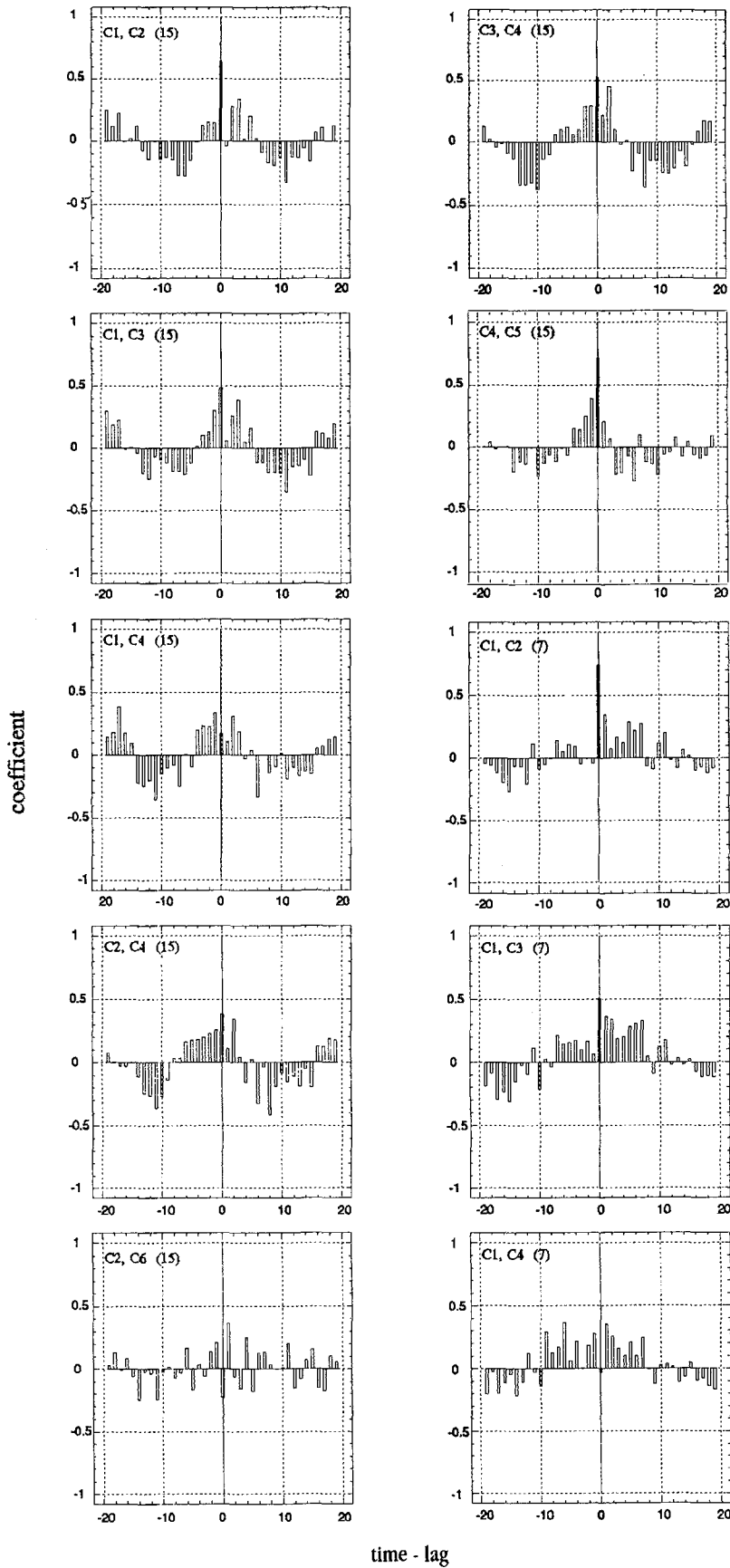
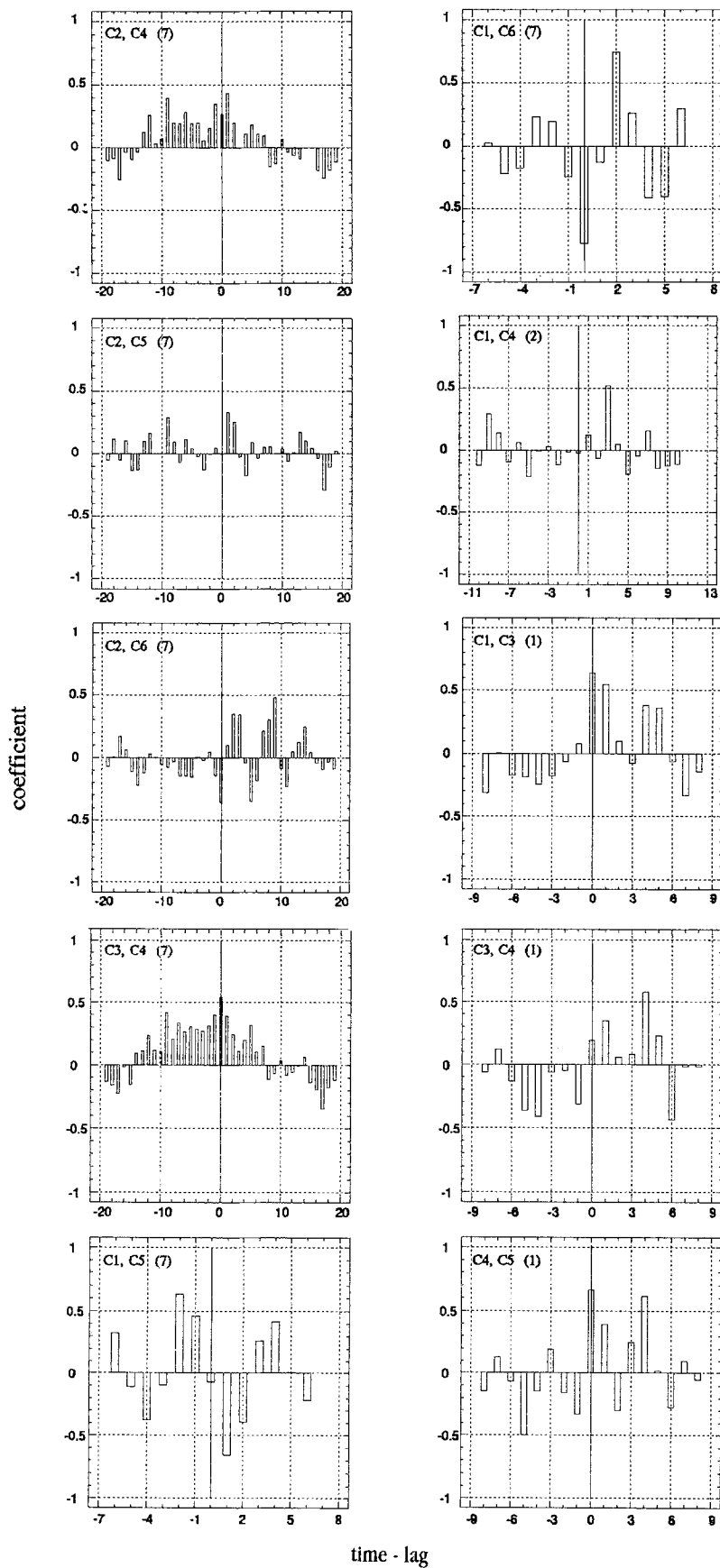

Fig. 3. *Acartia clausi*. Dendrograms and multidimensional-scaling plots of abundance of copepodite stages during November 1988 through June 1990; square-root transformed individuals/m<sup>3</sup> (a) and percentages (b)



**Fig. 4.** *Acartia clausi*. Statistically significant cross-correlations between abundance (%) of copepodite stages (see also Table 3). Time-series frequency (sampling frequency: 7 or 15 d) is shown in parentheses



**Fig. 5.** *Acartia clausi*. Statistically significant cross-correlations between abundance (%) of copepodite stages (see also Table 3). Time-series frequency (sampling frequency: 1, 2 or 7 d) is shown in parentheses

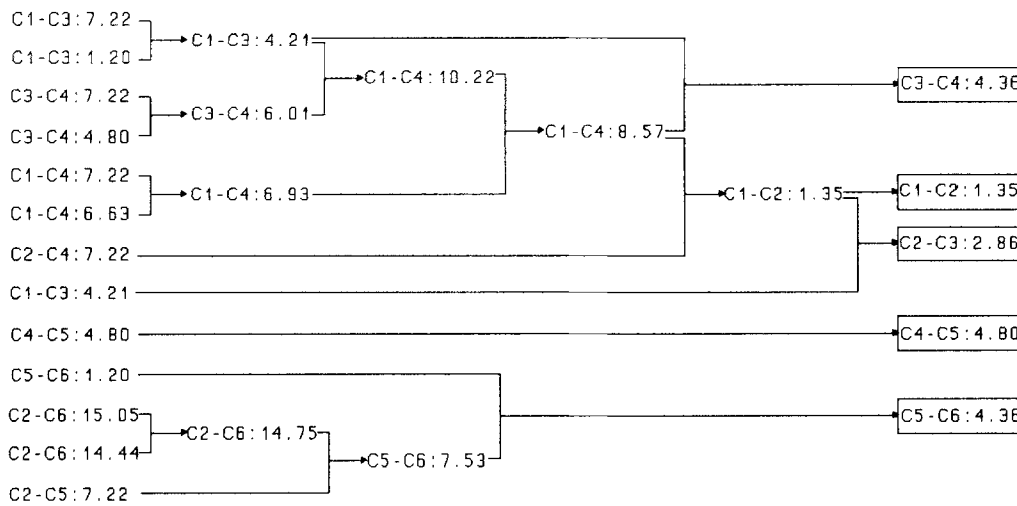

**Fig. 6.** *Acartia clausi*. Estimated durations (d) of Stages C1 to C5 based on data from Tables 1 and 3 (for computation see “Results”, Paragraph 4). Total time-interval between C1 appearance and C6 appearance was 17.7 d

**Table 3.** *Acartia clausi*. Statistically significant correlations between abundance (%) of Copepodite Stages C1–C6 (see Figs. 3 and 4). *t*: sampling frequency (d)

(n)	x	y	t	time-lag	r	P
(39)	C1	C2	15	3	0.339	<0.05
(39)	C1	C3	15	3	0.388	<0.02
(39)	C1	C4	15	-1	0.339	<0.05
(39)	C2	C4	15	2	0.349	<0.05
(39)	C2	C6	15	1	0.365	<0.05
(39)	C3	C4	15	2	0.452	<0.005
(39)	C3	C5	15	1	0.378	<0.02
(39)	C3	C5	15	-1	0.326	<0.05
(39)	C4	C5	15	-1	0.394	<0.02
(38)	C1	C2	7	1	0.342	<0.05
(38)	C1	C3	7	1	0.363	<0.05
(38)	C1	C4	7	1	0.349	<0.05
(38)	C2	C3	7	1	0.461	<0.005
(38)	C2	C4	7	1	0.434	<0.01
(38)	C2	C4	7	-1	0.353	<0.05
(38)	C2	C5	7	1	0.331	<0.05
(38)	C2	C6	7	2	0.351	<0.05
(38)	C2	C6	7	3	0.342	<0.05
(38)	C3	C4	7	-1	0.402	<0.02
(38)	C3	C4	7	1	0.394	<0.02
(12)	C1	C5	7	-2	0.636	<0.05
(12)	C1	C6	7	2	0.746	<0.02
(20)	C1	C4	2	3	0.520	<0.05
(16)	C1	C3	1	1	0.547	<0.05
(16)	C3	C4	1	4	0.580	<0.05
(16)	C4	C5	1	4	0.617	<0.05
(16)	C5	C6	1	1	0.559	<0.05

val between the occurrence of two copepodite stages was estimated as the product of the cross-correlation time-lag and the frequency of the time-series. On the assumption that the above relationships illustrate stages belonging to the same or to two successive generations, the results were classified into two groups as a function of the length of the time-interval between any two stages (Fig. 6, Table 4). The initial relationships (Fig. 6) represent the results of the cross-correlation analysis of individuals in the

**Table 4.** *Acartia clausi*. Time-intervals (d) between copepodite stages (data from Table 3) for two successive generations, and estimation of generation length (G, days), (for computation see “Results”, Paragraphs 4 and 5). *t*: sampling frequency (d)

Stage transition	(n)	t	time-lag	days	G
C1–C2	(39)	15	3	45.15	43.80
C1–C3	(39)	15	3	45.15	40.94
C2–C4	(39)	15	2	30.10	22.88
C3–C4	(39)	15	2	30.10	25.74
C4–C1	(39)	15	1	15.05	23.62
C5–C3	(39)	15	1	15.05	24.21
C5–C4	(39)	15	1	15.05	19.85
C5–C1	(12)	7	2	14.08	27.55
$\bar{x}$					28.57
(SE)					(3.12)
C1–C6				17.73	
C6–C1				10.84 <sup>a</sup>	

<sup>a</sup> Time-interval between appearance of adults (C6) and appearance of C1 of next generation

same generation. Whenever the time-interval between two similar stages varied, the mean was taken. The results (Fig. 6) indicated development times of 1.36, 2.86, 4.36, 4.80, 4.36 d for Copepodite Stages 1, 2, 3, 4, and 5, respectively, i.e., a total development time of 17.73 d between the first and the sixth copepodite stage.

Generation length (G, Table 4) was estimated from the development time of the various stages (Fig. 6) and the time-intervals between copepodite stages for two successive generations (Table 4). The mean G (= 28.6 d) was considered to be the mean generation length for the whole study period. Assuming that hatching lasts about 23 h (Ueda 1981), the time between hatching and the appearance of C1 was estimated at 10 d.

Based on the fluctuations in the female: male ratio for Stages C5 and C6 over the whole study period (Fig. 7), the number of generations/year would seem to be 4 or 5.

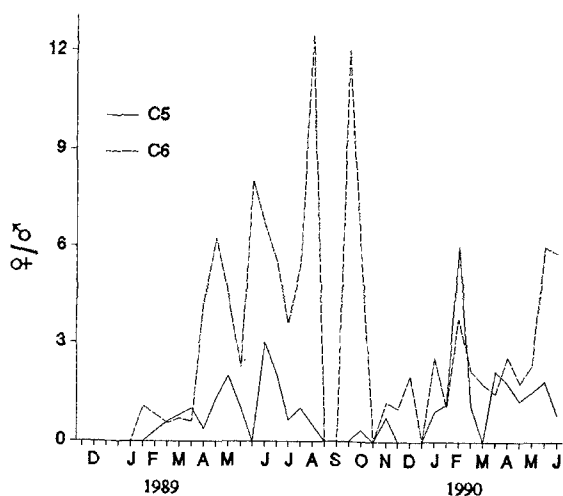

Fig. 7. *Acartia clausi*. Variations in sex ratio of Copepodite Stages C5 and C6 during November 1988 through June 1990

## Discussion

For all stages of *Acartia clausi*, highest abundance was observed in the spring. The increased proportion of mature copepods (28%) at this time is probably the result of their greater longevity compared with that of the copepodite stages.

The large changes in abundance (Figs. 1 and 2), especially on a daily basis (Fig. 2), may be attributable to the following factors: (a) hydrodynamic processes which are considered to play an important role in short-term changes in the abundance of zooplankton (Lindahl and Perissinotto 1987); (b) copepod motility in order to avoid environmental pressures arising from water turbulence and suspended particulate matter (Garcia-Soto et al. 1990); (c) occasional formation of *Acartia clausi* swarms, related to sex and development stages, which occur in temperate waters (Ueda et al. 1983, Sekiguchi 1985).

The almost simultaneous increase in abundance of all stages may be due to hydrodynamic processes, such as the wind-driven circulation prevailing in the area (Laskaratos and Kaltsounidis 1989), a factor which seems significantly to affect the distribution of *Acartia clausi*. This masks any differences in fluctuations in abundance of the various stages and makes visual identification of the cohorts impossible. In order to minimize the effect of such exogenous parameters, relative abundances (percentages) were used instead of absolute abundance. Fluctuations in abundance for all stages were similar for both analyses based on numerical abundances (individuals/m<sup>3</sup>) and those based on percentage abundance (%) (Fig. 3), a fact which confirms that percentage abundance can be used for the estimation of stage duration.

By means of cross-correlation analysis, it was possible to identify statistically significant relationships between any two stages; such relationships have not emerged in similar studies, which compared graphical representations of abundance (Gaudy 1976, 1984, Uye 1982, Uye et al. 1983). This method may significantly contribute to the identification of cohorts, and hence to the estimation of stage duration, from field data for a given copepod species.

The development of *Acartia clausi* stages was not isochronal. The duration of the first copepodite stage was shorter than that for each of the last three stages, between which the duration did not seem to differ significantly. The time between the appearance of the first (C1) and the sixth (C6) stages was estimated to be 17.7 d. Copepodite Stage C2 lasted twice as long as C1, whereas the development times for C3–C5 were similar, being three times as long as that for C1.

Temperature and food availability are considered to be the most important factors affecting the growth rate of copepods (Corkett and McLaren 1970, Landry 1975, Klein Breteler et al. 1982). Laboratory observations have shown the development of *Acartia clausi* to be isochronal in the presence of excess food and a favourable temperature range. This has been considered to be an adaptation leading to a shorter biological cycle and higher rates of population increase (Miller et al. 1977, Uye 1980, Pagano and Saint-Jean 1983).

Although laboratory studies examining the duration of copepodite stages report a dependence on temperature (Thompson 1982, Landry 1983), they also raise questions about the relevance of the direct application of rigid mathematical relationships such as the "isochronal rule" (Miller et al. 1977) to describe copepod growth. Hay et al. (1988) believed that the flexibility in development rate revealed by their data was a response by the copepods to some environmental factor other than temperature, such as food composition. Finally, the number of copepod species exhibiting isochronal development are generally lower than those exhibiting non-isochronal development (i.e., faster growth during the first few stages, slower growth towards the later stages of the life cycle: Uye 1980).

The following generation lengths were recorded during laboratory experiments on *Acartia clausi* supplied with an excess of food: 25 d at 14 to 16°C, Corkett (1968); 19.4 d at 15°C, 16.7 d at 20°C, Iwasaki et al. (1977); 21 d at 15°C, Landry (1978); and 27 to 14.2 d at 13 to 20°C, Uye (1980). Estimations from field observations were: in Villefranche-Sur-Mer (western Mediterranean) 29.5 d at 15 to 20°C, Gaudy (1976); in Loch Striven (Scotland) 28 to 42 d at 13.5 to 8.5°C, McLaren (1978); whereas in the Lister Ley (northern Wadden Sea of Sylt, German Bight), the generation length was 35 to 38.5 d (Martens 1981).

The mean generation length recorded in the present study (28.6 d) seems to be among the highest recorded in the literature, at the temperature range prevailing in the area. Because the samples used in this study were collected over a 20 mo period and hence covered a wide range of temperatures (~13 to 25°C), the effect of temperature on generation length can not be assessed. The duration of each stage and generation length are therefore both expressed as means.

Food limitation of zooplankton feeding and growth has received a great deal of attention in the literature. In waters of such high chlorophyll content as Jakle's Lagoon, USA (4 to 60 µg/l: Landry 1978) and Narragansett Bay, USA (2 to 52 µg/l: Durbin et al. 1983), physiological processes of *Acartia* species can be limited by food concentration. Thus, since the chlorophyll *a* recorded in the

waters of the Saronikos Gulf was  $<0.47 \mu\text{g/l}$  on more than half the sampling dates (Christou unpublished data), low food availability could be expected to have had a limiting effect on growth rate and hence the generation time of *A. clausi*. Moreover, such food limitation could itself affect, at least partially, the relative duration of the various stages; i.e., periods with low food levels could have increased the duration of some stages (compared to each other) above the expected values (e.g. expected  $C4 < C5$ ; estimated  $C4 > C5$ , Fig. 6). Food availability could therefore act as a limiting factor on the duration of each or any stage and hence affect the total generation length. Food deficiency (cultured phytoplankton or natural food) has been found to delay the development and increase the duration of copepodite stages in various copepods (Vidal 1980, Kawabata 1989, Hart 1991). The low food levels typical of the study area, may increase stage duration by delaying development and, hence, generation length, resulting in numerically poor populations, a situation which is in accordance with the very poor conditions, even of the neritic zone, of the eastern Mediterranean Sea (Azov 1991).

The variations in the female: male ratio indicate 4 or 5 annual generations for *Acartia clausi* (Fig. 7), a result similar to other reports in the literature for the same species in other temperate regions (e.g. 4 generations in Scotland, McLaren 1978; 4 to 6 generations in Japan, Ueda 1978, Uye 1982).

*Acknowledgements.* We are grateful to R. Friedrich for useful comments and suggestions. We also thank Dr. K. I. Stergiou and Mrs. M. Kontaris for assistance in the text revision.

## Literature cited

- Azov, Y. (1991). Eastern Mediterranean – a marine desert? *Mar. Pollut. Bull.* 23: 225–232
- Bougis, P. (1976). Marine plankton ecology, North-Holland, Amsterdam
- Bray, J. R., Curtis, J. T. (1957). An ordination of the upland forest communities of Southern Wisconsin. *Ecol. Monogr.* 27: 325–349
- Burkill, P. H., Kendall, T. F. (1982). Production of the copepod *Eurytemora affinis* in the Bristol Channel. *Mar. Ecol. Prog. Ser.* 7: 21–31
- Christou, E. (1990). Fluctuations of zooplankton, during spring and summer in a coastal area of the Saronikos Gulf. [in Greek] In: Proceedings of the Third Hellenic Symposium of Oceanography and Fisheries. N.C.M.R., Athens, p. 513–520
- Clarke, K. R., Green, R. H. (1988). Statistical design and analysis for “biological effects” study. *Mar. Ecol. Prog. Ser.* 46: 213–226
- Clarke, K. R., Warwick, M. (1989). Lecture notes on the statistical treatment and interpretation of marine community data. Part II. In: Report of the training workshop organised in the framework of the long-term programme for the pollution, monitoring and research in the Mediterranean (MED POL-Phase II), Athens, September 1989. United Nations Environment Programme, Athens, p. 91–124
- Corkett, C. J. (1968). La reproduction en laboratoire des copépodes marins *Acartia clausi* Giesbrecht et *Idya furcata* Baird. *Pélagos, Bull. Inst. océanogr. Alger.* 10: 77–90
- Corkett, C. J., McLaren, I. A. (1970). Relationships between development rate of eggs and older stages of copepods. *J. mar. biol. Ass. U. K.* 50: 161–168
- Durbin, E. G., Durbin, A. G., Smayda, T. J., Verity, P. G. (1983). Food limitation of production by adult *Acartia tonsa* in Narragansett Bay Rhode Island. *Limnol. Oceanogr.* 28: 1199–1213
- Edmondson, W. T., Winberg, G. G. (1971). A manual on methods for the assessment of secondary production in fresh waters. Blackwell, Oxford (IBP Handbook No. 17)
- Field, J. G., Clark, K. R., Warwick, R. M. (1982). A practical strategy for analyzing multispecies distribution patterns. *Mar. Ecol. Prog. Ser.* 8: 37–52
- Field, J. G., McFarlane (1968). Numerical methods in marine ecology. I. A quantitative similarity analysis of rocky shore samples in False Bay, South Africa. *Zoologica african.* 3: 119–138
- Friligos, N. (1982). Enrichment of inorganic nutrients in the Inner Saronikos Gulf (1973–1976). *Mar. Pollut. Bull.* 13: 154–158
- Friligos, N. (1984). Nutrients of the Saronikos Gulf in relation to environmental characteristics (1973–1976). *Hydrobiologia* 112: 17–25
- Garcia-Soto, C., de Madariaga, I., Villate, F., Orive, E. (1990). Day-to-day variability in the plankton community of a coastal shallow embayment in response to changes in river runoff and water turbulence. *Estuar., cstl. Shelf Sci.* 31: 217–229
- Gaudy, R. (1970). Contribution à la connaissance du cycle biologique et de la physiologie de copépodes du golfe de Marseille. Thèse d'Etat, Université de Marseille
- Gaudy, R. (1976). Etude du placton de la zone de la rade de Villefranche-Sur-Mer à la fin de printemps (17 mai au 16 juin 1971). *Vie Milieu* 26: 77–106
- Gaudy, R. (1984). Biological cycle of *Centropages typicus* in the North-Western Mediterranean neritic waters. *Crustaceana (Suppl.)* 7: 200–213
- Greze, V. N. (1978). Production in animal populations. In: O. Kinne (ed.) *Marine ecology. IV. Dynamics.* Wiley & Sons, London, p. 89–114
- Hart, R. C. (1991). Food and suspended sediment influences on the naupliar and copepodid durations for freshwater copepods: comparative studies on *Tropodiptomus* and *Metadiptomus*. *J. Plankton Res.* 13: 645–660
- Hay, S. J., Evans, G. T., Gamble, J. C. (1988). Birth, growth and death rates for enclosed populations of calanoid copepods. *J. Plankton Res.* 10: 431–454
- Herman, P. M. J., Heip, C., Guillemijn, B. (1984). Production of *Tachidius discipes* (Copepoda: Harpacticoida). *Mar. Ecol. Prog. Ser.* 17: 271–278
- Ianora, A., Mazzochi, M. G., Scotto Di Carlo, B. (1985). Zooplankton community structure for coastal waters of the gulf of Naples in the summer of 1983. *Rapp. P.-v. Réun. Commn. int. Explor. scient. Mer Méditerr.* 29: 299–300
- Ignatiades, L., Karydis, M., Vassiliou, A., Moschopoulou, N. (1982). Hydrography. [in Greek] Data report of phytoplankton ecology of Saronikos Gulf, Aegean Sea. Nuclear Research Centre Democritos, Athens [DEMO (82/1)]
- Ignatiades, L., Moschopoulou, N., Karydis, M., Vassiliou, A. (1983). Phytoplankton. [in Greek] Data report of phytoplankton ecology of Saronikos Gulf, Aegean Sea. Nuclear Research Centre Democritos, Athens [DEMO (83/8)]
- Iwasaki, H., Katoh, H., Fujiyama, T. (1977). Cultivation of marine copepod *Acartia clausi* Giesbrecht. I. Factors affecting the generation time and egg production. *Bull. Plankton Soc. Japan* 24: 55–61
- Kawabata, K. (1989). Natural development time of *Eudiaptomus japonicus* (Copepoda: Calanoida) in Lake Biwa. *J. Plankton Res.* 11: 1261–1271
- Kimmerer, W. J., McKinnon, A. D. (1985). A comparative study of zooplankton in two adjacent embayment, Port Phillip and Westernport Bays, Australia, Estuar., cstl. Shelf Sci. 21: 145–159
- Klein Breteler, W. C. M., Franz, H. G., Gonzalez, S. R. (1982). Growth and development of four calanoid copepod species under experimental and natural conditions. *Neth. J. Sea Res.* 16: 195–207
- Landry, M. R. (1975). The relationship between temperature and the development of life stages of the marine copepod *Acartia clausi* Giesbrecht. *Limnol. Oceanogr.* 20: 854–857
- Landry, M. R. (1978). Population dynamics and production of a planktonic marine copepod, *Acartia clausi*, in a small temperate



- lagoon on San Juan Island, Washington. *Int. Revue ges. Hydrobiol.* 63: 77–119
- Landry, M. R. (1983). The development of marine calanoid copepods with comment on the isochronal rule. *Limnol. Oceanogr.* 28: 614–624
- Laskaratos, A., Kaltounidis, N. (1989). The Inner Saronikos Gulf physical oceanography: elaboration of existing data and measurements of sea level. [in Greek] Final report on the study of the hydrodynamics and pollution by the effluents of Athens. University of Athens, Athens
- Legendre, L., Legendre, P. (1983). *Numerical ecology*. Elsevier, New York
- Lindahl, O., Perissinotto, P. (1987). Short-term variations in the zooplankton community related to water exchange in the Gullmar fjord, Sweden. *J. Plankton Res.* 9: 1113–1132
- Martens, P. (1981). On the *Acartia* species of the northern Wadden Sea of Sylt. *Kieler Meeresforsch.* 5: 153–163
- McLaren, I. A. (1978). Generation lengths of some temperate marine copepods: estimation, prediction and implications. *J. Fish. Res. Bd Can.* 35: 1330–1342
- Miller, C. B., Johnson, J. K., Heinle, D. R. (1977). Growth rules in the marine copepod genus *Acartia*. *Limnol. Oceanogr.* 22: 326–335
- Omori, M., Ikeda, T. (1984). *Methods in marine zooplankton ecology*. Wiley & Sons, New York
- Pagano, M., Saint-Jean, L. (1983). Croissance en poids d'*Acartia clausi* en lagune Ébrié (Côte d'Ivoire). *Revue Hydrobiol. trop.* 16: 151–163
- Sekiguchi, H. (1985). Biology of cladocerans and copepods in Ise Bay. 2. Vertical distribution of neritic copepods in relation to their life histories. *Bull. Fac. Fish. Mie Univ.* 12: 1–12
- Sokal, R. R., Sneath, P. H. A. (1963). *Principles of numerical taxonomy*. W. H. Freeman & Co., San Francisco
- Specchi, M., Fonda Umani, S., Radini, G. (1981). Les fluctuations du zooplancton dans une station fixe du Golfe de Trieste (Haute Adriatique). *Rapp. P.-v. Réun. Commn int. Explor. scient. Mer Méditerr.* 27: 97–100
- Sullivan, B. K., McManus, L. T. (1986). Factors controlling seasonal succession of the copepods *Acartia hudsonica* and *A. tonsa* in Narragansett Bay, Rhode Island: temperature and resting egg production. *Mar. Ecol. Prog. Ser.* 28: 121–128
- Thompson, B. M. (1982). Growth and development of *Pseudocalanus elongatus* and *Calanus* sp. in the laboratory. *J. mar. biol. Ass. U.K.* 62: 359–372
- Tranter, D. J. (1976). Herbivore production. In: Rushing, D. H., Walsh, J. J. (eds.) *The ecology of the seas*. Blackwell, Oxford, p. 186–224
- Tranter, D. J., Smith, P. E. (1968). Zooplankton sampling, *Monogr. oceanogr. Methodol. (UNESCO)* 2: 27–56
- Ueda, H. (1978). Analysis of the generations of inlet copepods with special reference to *Acartia clausi* in Maizuru Bay, middle Japan. *Bull. Plankton Soc. Japan* 25: 55–66
- Ueda, H. (1981). Hatching time of *Acartia clausi* (Copepoda) eggs isolated from the seawater in Maizuru Bay. *Bull. Plankton Soc. Japan* 28: 13–17
- Ueda, H., Kuwahara, A., Tanaka, M., Azeta, M. (1983). Underwater observations on copepod swarms in temperate and subtropical waters. *Mar. Ecol. Prog. Ser.* 11: 165–172
- Uye, S. (1980). Development of neritic copepods *Acartia clausi* and *A. steueri*. II. Isochronal larval development at various temperatures. *Bull. Plankton Soc. Japan* 27: 11–18
- Uye, S. (1982). Population dynamics and production of *Acartia clausi* Giesbrecht (Copepoda: Calanoida) in inlet waters. *J. exp. mar. Biol. Ecol.* 57: 55–83
- Uye, S., Iwai, Y., Kasahara, S. (1983). Growth and production of the inshore marine copepod *Pseudodiaptomus marinus* in the central part of the Inland Sea of Japan. *Mar. Biol.* 73: 91–98
- Vidal, J. (1980). Physioecology of zooplankton. II. Effects of phytoplankton concentration, temperature, and body size on the development and molting rates of *Calanus pacificus* and *Pseudocalanus* sp. *Mar. Biol.* 56: 135–146
- Woodmansee, R. A. (1958). The seasonal distribution of the zooplankton of Chicken Bay, Florida. *Ecology* 39: 247–262

Communicated by J. M. Pérès, Marseille